

CAMPING
& OUTDOOR
BRAND

2019

PRODUCT
CATALOG

2019 KOVEA PRODUCT CATALOG

BEYOND THE LIMITS

KOVEA







KOVEA CO., LTD .

202-401, Bucheon Technopark, 388, Songnae-daero, Bucheon-si, Gyeonggi-do 14502, Korea
Tel +82 32 621 2170 Fax +82 32 621 2175 E-mail koveatd@kovea.com
www.kovea.com



CONTACT US

-  **HOMPAGE** : <http://www.kovea.com>
 -  **FACEBOOK** : <http://www.facebook.com/koveagear>
 -  **TWITTER** : <http://twitter.com/KoveaGear>
 -  **INSTAGRAM** : <http://instagram.com/KoveaGear>
-

KOVEA
Beyond the limits

































CONTENTS

1	2	3	4	5	6	7	8
4p	6p	22p	38p	44p	56p	64p	82p
KOVEA HISTORY	NEW PRODUCT	GAS STOVE & HEATER	GAS·LED LANTERN	TORCH & BARBECUE GRILL	COOKWARE & ACCESSARY	CAMPING & ETC.	TRANGO



KOVEA HISTORY

Kovea has contributed to the creation and expansion of outdoor and camping culture through out the world. As a result of those efforts, we have received several awards from various institutions by achieving recognition of brilliant design and innovative performance. Kovea stands for top rated customer satisfaction, superior quality and development of new innovative products.

1982~1983	1987	1989	1991	1992~1994	1995~1996	1997	1999~2000
<p>Kovea Company is established.</p> <p>Kovea develops its first gas burner.</p>	<p>TKB-8711 Burner First Camping top mount canister stove developed for 230g gas canister.</p> <p>TKB-8712 Burner Koreas first auto ignition top mount canister stove developed. Still in production to this date, one of our most reliable and logest top mount canister stoves.</p>	<p>KTL-894 (Gas Lantern) 1st Gas powered Lantern for the backpacking community Along with the TKB-8712, Koveas flagship burner and lantern.</p> <p>TKB-8911 After the success of the 8711 model, the more fuel efficient model developed. New auto ignition starter developed with a new design concept.</p>	<p>KB-9110 (Handy Twin Stove) 2 head burner stove developed for multi purpose cooking.</p> <p>Portable Burner System (Burner + Cookware) First portable all in one stove system developed.</p>	<p>TKH-9208 Koreas first portable gas heater developed.</p> <p>TKB-9401 (Deluxe Twin Stove) International Gas adaptor patent registered. One touch adaptor system developed and patented.</p>	<p>Koveas first international order sent out to JAPAN.</p> <p>9607 Torch developed. (Auto Ignition)</p>	<p>Kovea Co., LTD established.</p> <p>TKB-9901 (Maximum Stove) Gas burner stove developed for Japanese market.</p> <p>TKB-9703 (Camp 1 Remote Canister Stove) Remote Canister stove with large burner head developed.</p>	<p>Sales Milestone achieved for Kovea. 2 years straight running.</p> <p>Presidential Award for exports received.</p> <p>Gas Safety Award received.</p> <p>KH-2006 (Sense Heater)</p>
 <p>TKB-8712</p>	 <p>TKB-894</p>  <p>TKB-8911</p>	 <p>KB-9110</p>  <p>Burner+Cookware</p>	 <p>TKH-9208</p>  <p>TKB-9401</p>	 <p>KGT-9607</p>	 <p>TKB-9901</p>  <p>TKB-9703</p>	 <p>KH-2006</p>	
2001~2002	2004~2005	2006~2009	2011~2012	2013~2014	2015~2016	2017	2018
<p>KB-0101 (Titanium Burner)</p> <p>TRANGO established.</p> <p>KH-0203 (Little sun heater)</p> <p>KB-0211 (Moonwalker)</p>	<p>KOVEA Logo Brand developed. With the boomerang in mind, Kovea establishes its logo with the concept that people will keep coming back to Kovea with all the new products developed for the outdoor and home industry.</p> <p>KG-0409 (3 Way all in one) Koveas first All in one Gas BBQ Grill for all types of cooking.</p>	<p>KB-0603 (Booster+1) Worlds first multi fuel Gas stove that doesn't require any nozzle changes.</p> <p>KB-0703 (Alphine Pot) Kovea develops the Stove and cookware burner system.</p> <p>KGB-0812 (AL II Chef Master Hose Burner) Regulated 2 burner stove to incorporate remote canister access.</p>	<p>KB-N0810 (Dual Max) New and improved design of the Booster+1 Stove.</p> <p>30 Year Anniversary Camping Festival. As a thank you th the customers, Camping Festival launched 2 times per year.</p> <p>KH-1203 (Cupid Heater) Compact portable gas heater developed.</p>	<p>KH-1310 (Giga Sun) Family Style heater developed and given ISPO Design Award.</p> <p>ISPO Gold Design Award and Reddot Award received for numerous products. L Core Lantern, System Cookware.</p>	<p>KGR-1503 (Cube) Stainless Steel gas range developed and designed. Unique design wins numerous awards.</p> <p>Alphine Pot EZ-Eco & Cube wins ISPO Gold Design Award.</p> <p>KGB-1312A (Slim Twin Stove Lite) Winner from Gear Institute for Best New Gear Awards.</p> <p>1st win KOREA Brand Power Index.</p>	<p>E-Stove wins IF Gold Design Award.</p> <p>KGB-1305 (Hydra) Winner from Back Country Skiing Canada for Gear of the year awards.</p> <p>KGB-1701 (Alpine Master) All in One inclusive system.</p>	<p>Forbes rated #1 Camping Brand in Korea 6 years straight running.</p> <p>KGG-1805 (Mini) Retro all in one system developed.</p> <p>KGT-1808 (Octa) Lightweight compact designed Torch developed.</p>
 <p>KB-0101</p>  <p>KH-0203</p>  <p>KB-0211</p>	 <p>KG-0409</p>	 <p>KB-0603</p>  <p>KB-0703</p>  <p>KGB-0812</p>	 <p>KB-N0810</p>  <p>KH-1203</p>	 <p>KH-1310</p>  <p>L Core Lantern & System Cookware</p>	 <p>KGR-1503</p>  <p>KGB-1410</p>  <p>KGB-1312A</p>	 <p>E-Stove</p>  <p>KGB-1305</p>  <p>KGB-1701</p>	 <p>KGG-1805</p>  <p>KGT-1808</p>

1



NEW PRODUCT

INITIALS

B: Bulb(LED) **Ba**: Battery **C**: Consumption **D**: Dimension **F**: Fuel
M: Material **Q**: Quantity **R**: Runtime **S**: Size **V**: Volume
W: Weight **Br**: Brightness **Cc**: Capacity **Cr**: Color
Fl: Filling **Rg**: Range **St**: Strength **Ig**: Ignition **IL**: illumination

ALPINE MASTER

KGB-1701
All inclusive stove system



Only need
2:40min / 1L

The Alpine master has a new Surface Combusting System and Heat Exchange System which allows for greater heating and fuel efficiency with faster boiling times.

Allows one to carry all the cooking components in one system, even the gas canister. Ideal for outdoor activities such as fishing, camping, and backpacking.

Specification

- D** 178 x 178 x 213mm (Inner Box)
- W** 883g
- Cc** 2,000ml
- Ig** Manual Ignition
- F** Iso-Butane (Screw Type Gas Canister)
- C** 162g/h (1,916kcal / 7,605BTU / 2.23kW)
- M** Stainless, Aluminium

NEW PRODUCT

SCS + HES

With the Surface Combustion System and the newest heat exchange system, this stove has one of the fastest boil times on the market. Only taking 2 mins 40 secs to boil 1 liter of water.

*Test Condition : Water temperature of 20°C in a controlled environment.



All inclusive stove system



The container for private use of 2 liter size!

The Pot can hold up to 2 liters. Also lid for pot can be used as a fry pan. Allowing for the Pot to cook rice and fry an egg on the frying pan.

*For safety purpose, fill up to 1.2 liter.

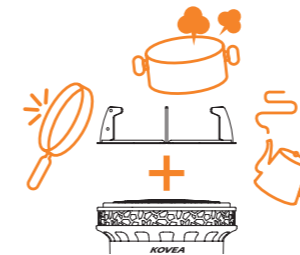

Use various containers.

Possible to use various containers. With the pot support attachment one has the ability to use other cookware with the stove.

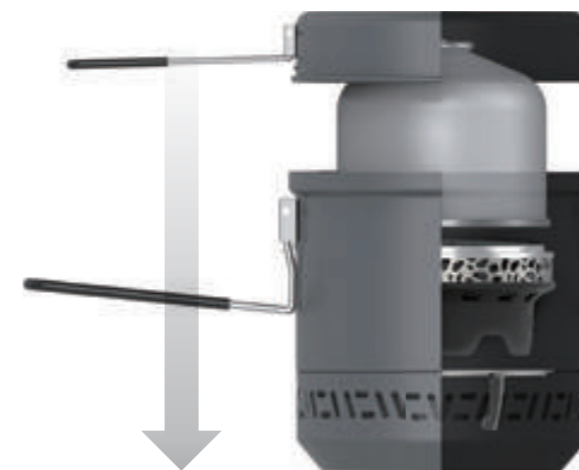
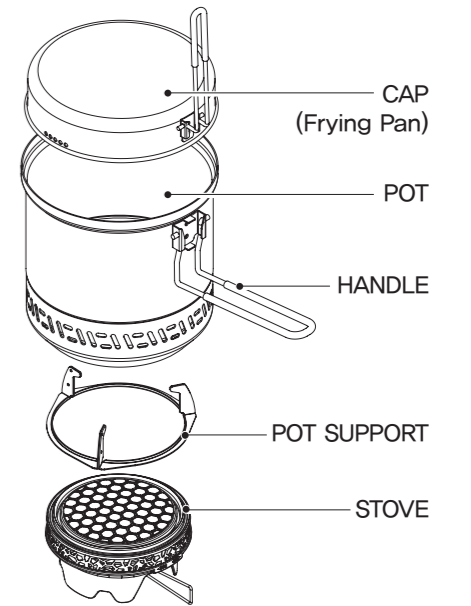

Compact



Carry the stove, pot support, and fuel canister in the pouch provided.



All of the components nestle in the pouch provided.

MINI

KGG-1805

Retro integrated stove system



Compact system

Mini is designed to store the pot inside of the main burner, perfect for outdoor activities. Use of a pot support, cookware, pots, frying pans and a variety of cooking vessels are available. The Mini is a great way to cook your favorite dishes away from home.

Specification

- D** 318 x 275 x 117mm (Inner Box)
- W** 1.9kg
- Cc** 550ml
- Ig** One Touch Piezo Ignition
- F** Nozzle Type Gas Canister (220g)
- C** 110g/h (1,300kcal / 5,162BTU / 1.51kW)
- M** Lid-PC, Ceramic Pan-Ceramic Coating



NEW PRODUCT

Safety lock mechanism

The only reason for a gas canister explosion is the rise of internal pressure. This product has a regulator (it automatically cuts the gas flow when the pressure is rising over the certain limits) to prevent any kind of accident. Safety lock operates when the appliance is operated in the wrong way.

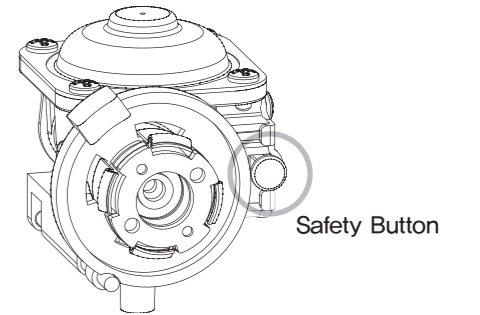

Compact system

- PC POLY CARBONATE** **1. LID & BOWL**
Made of high quality food safe PC. It is designed to be used as a bowl when cooking with lid.
- 2. POT SUPPORT**
Use a variety of cooking vessels with the pot support.
- COMPACT** **3. CERAMIC PAN**
The ceramic pan made with a ceramic coating, designed for easy storage and transportation.
- SAFETY** **4. SAFETY LEVER**
The bottom of the main body of the ceramic pan, designed to prevent the pan from moving around while not in use.



All inclusive stove system



Use of the ceramic coated cookware.
Various dishes such as BBQ, fried food, stews can be made.



Using pot support.
Cookware, pots, frying pans and a variety of cooking vessels can be used.

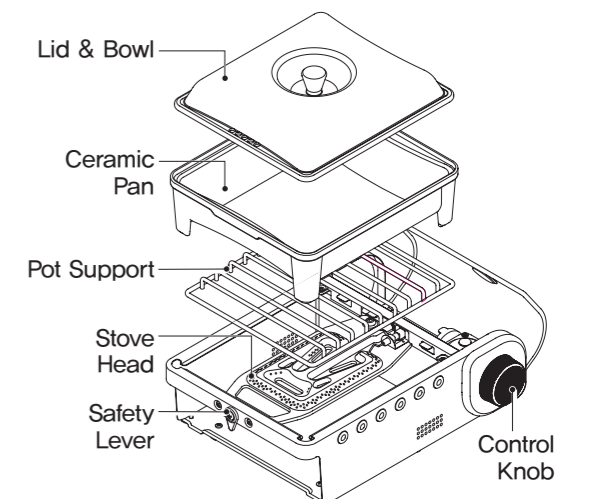

OCTA

KGT-1808

Ultra lightweight designed torch

Ergonomic Grip

Designed to minimize work fatigue, not only is it lightweight but fits the hand ergonomically.

Various practical applications such as cooking, simple welding, ball action, firewood ignition for camping, etc. are possible.

Specification

- D** 140 x 41 x 200mm (Blister Size)
- W** 93g
- Ig** One Touch Piezo Ignition
- F** Nozzle Type Gas Canister
- C** 105g/h (1,242kcal / 4,928BTU / 1.44kW)

Ultra lightweight

93g lightweight compact size minimizes work fatigue where it needs to be held for long periods of time.



Ergonomic grip

Designed to fit in the user's hands, minimizing work fatigue.



Uses



PVC pipes work.

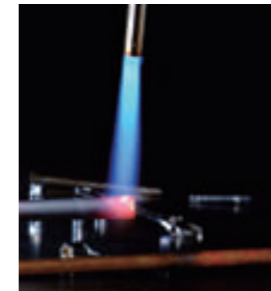

Simple welding thawing frozen water pipes.



Cooking.



Burning firewoods.

CAMP 1 PLUS

KGB-1608
High power stove

Most trusted all around stove

The Camp One Plus is an upgraded version of our most trusted stove, TKB-N9703 we increased its power to reduce boiling time and keep wind from being a factor.

Can separate main body and body wall which allows for easier cleaning. It also has a heating pipe which helps during colder temperatures and increases fuel efficiency.

Specification

- D** 140 x 90 x 145mm (Inner Box)
- W** 360g
- Ig** One Touch Piezo Ignition
- F** Iso-Butane (Screw Type Gas Canister)
- C** 140g/h (1,656kcal / 6,572BTU / 1,93kW)

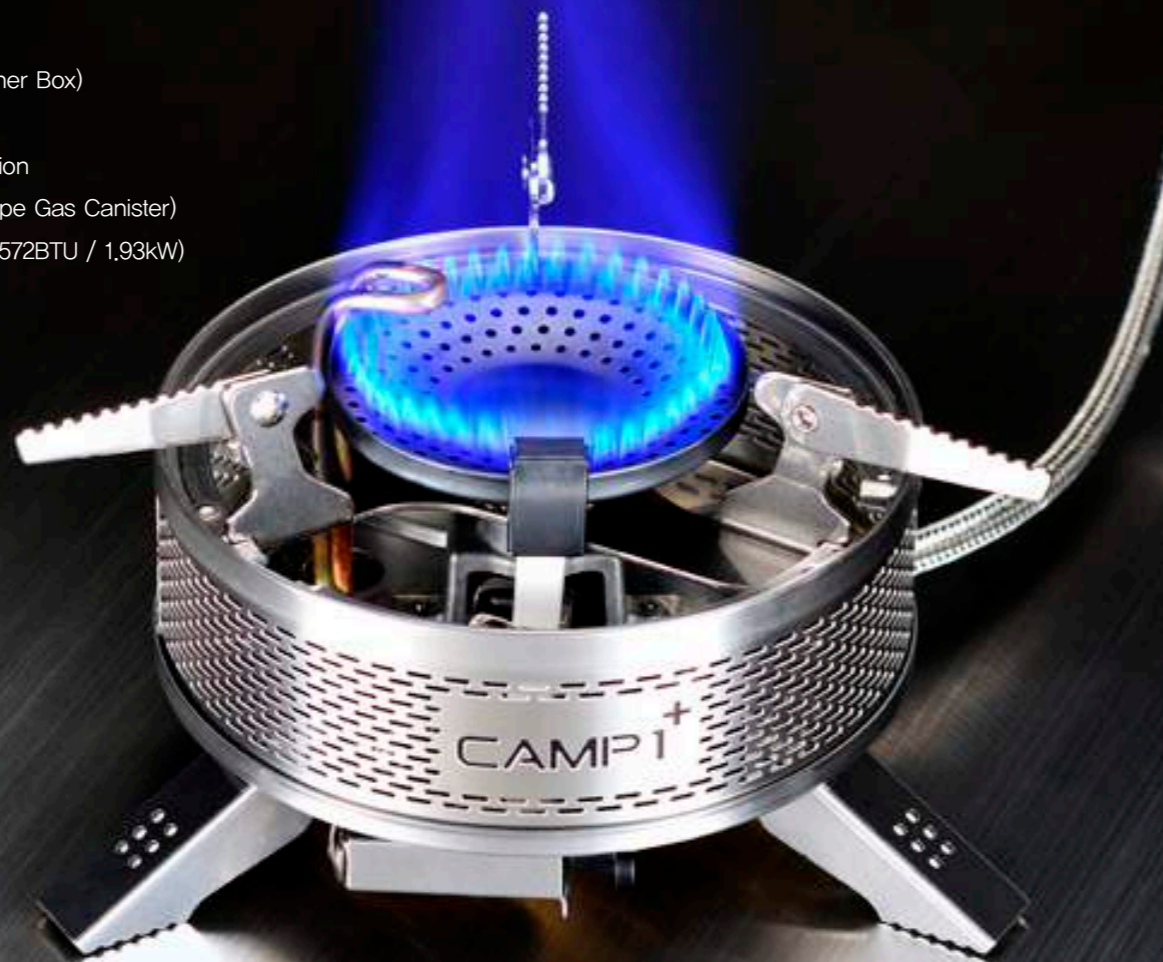

NEW PRODUCT

Concave stove head

Better performance of keeping the flame on the head. Concave stove head with reduced boiling time. Improvement of Performance by 15%.



Ceramic coated head

Ceramic coated burner head minimizes discoloration and deformation due to high temperature, enhancing product safety.

Cover for ignitor

The cover prevents damage during impact, prevents gas ruptures, and ensures a stable ignition.

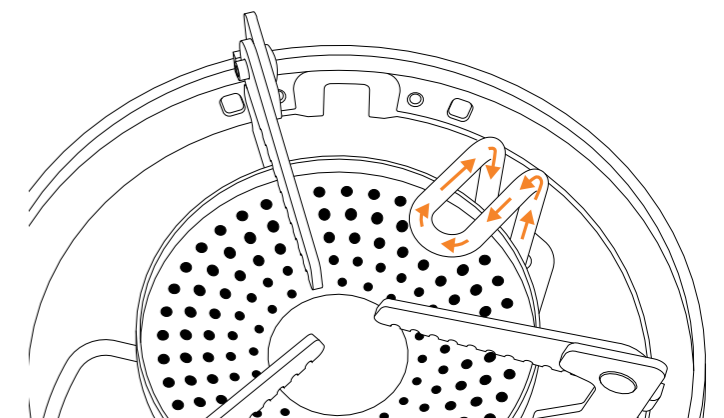

Gas heating pipe

The lowest possible vaporization temperature for butane gas is -0.5°C . At this temperature for butane gas combustion outdoors in winter is difficult. In order to solve this issue, gas flows through. Gas heating pipe near the stove's head to increase the evaporation of butane gas so that the burner can work effectively even in cold weather.

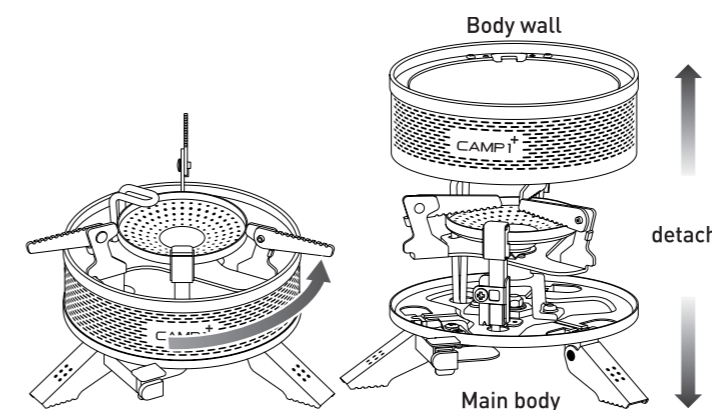

Easy to clean

Can separate main body and body wall which allows for easier cleaning.

SLIM TWIN STOVE LITE

KGB-1312A
Multi fuel stove

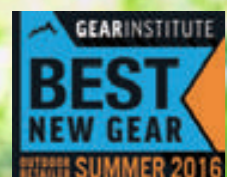

Most versatile 2 burner stove

The Gas canister can be directly connected to the bottom of the stove.
The height has been adjusted for use with different fuel canisters.
The most versatile 2 Burner stove on the market.
Never have to worry about what fuel to use.



Specification

- D** 542 x 340 x 72mm (Inner Box)
- W** 4.9kg
- Ig** One Touch Piezo Ignition
- F** Iso-Butane(Screw Type Gas Canister), Butane(Nozzle Type Gas Canister), Propan Gas
- C** Iso-Butane : 230g/h (2,721kcal / 10,797BTU / 3.22kW)
Butane : 201g/h (2,378kcal / 9,436BTU / 2.76kW)
Propane Gas : 316g/h (3,738kcal / 14,842BTU / 4.34kW)

NEW PRODUCT

Multi fuel system

Two different adapters are included for any fuel canister on the market. (Propane, ISO Butane and Butane)



Butane Adapter x 2ea



Propane Adapter x 2ea



16.4
oz

PROPANE



7.4
oz

BUTANE GAS



16
oz

ISO-BUTANE GAS



8
oz

4
oz



Basic



Propane



Butane



Butane MIX



Propane MIX

Wide burner heads and removable lid

Larger pots and pans are available.

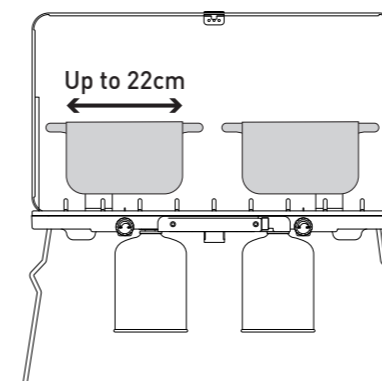

Increased thermal efficiency by attaching the wind shield on the wings of the stove.

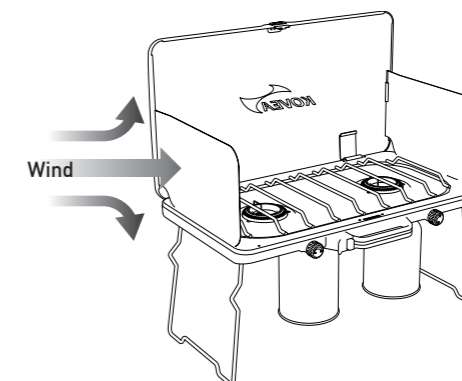

Removable lid allows for use of larger pots.

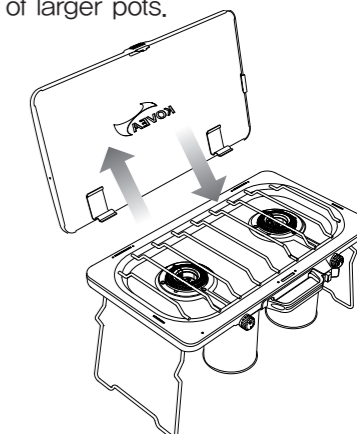

The slimmest two burner stove on the market

Perfect for saving space while camping.

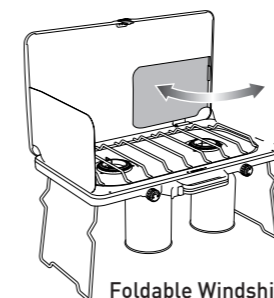

Foldable Windshield

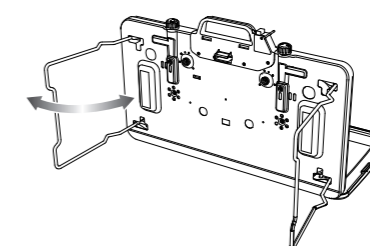

Foldable stove support

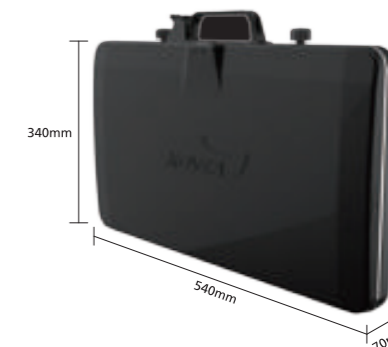

HANDY SUN

KGH-1609
Compact portable heater



Small in size, Tons of heat

The Handy Sun is our newest, smallest and lightest heater in our product line.

This small heater is great for trips where it gets a bit cold and you need something to warm you up.

Specification

- D** 158 x 158 x 195mm
- W** 197g
- Ig** One Touch Piezo Ignition
- F** Iso-Butane (Screw Type Gas Canister)
- C** 60g/h (710kcal / 2,817BTU / 0.82kW)

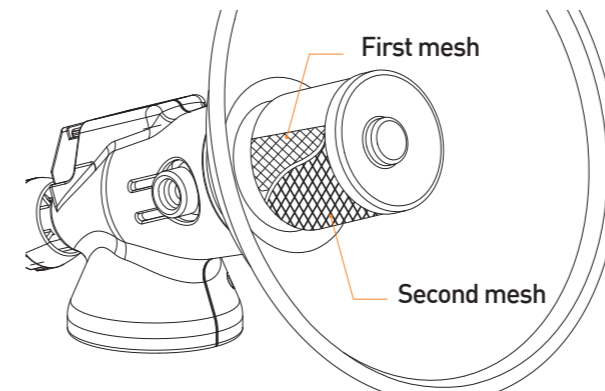

Large radial double mesh

The radial 2 layered mesh collect and store the heat simultaneously and creates great heat efficiency.

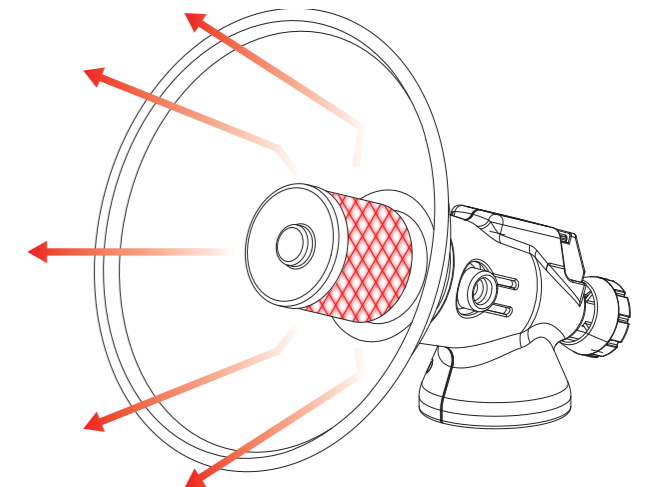

Excellent heat efficiency

The reflector plate around the head comprised of aluminum due to material creating max heat reflection as apposed to any other material.

It is a product with excellent heat efficiency due to heat concentration in every direction by the reflector.



The safety net

Prevent any damage from high temperature.

One touch piezo ignition

Easy to ignite with a trigger type ignition.

Air shutter

Easy to ignite by pressing the Air Shutter while igniting.

Fine adjustment

Control knob that provides fine flame adjustment.

Uses



Fishing



Mountain climbing



Camping

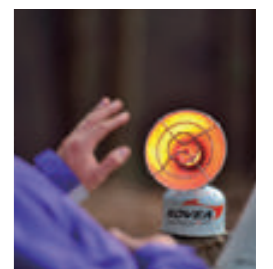

Backpacking

ALPINE POT WIDE UP

KB-0703WU
All inclusive stove system



Only need
2:40 min / 0.5L

The Alpine Pot Wide Up is an upgraded version of our Alpine Pot Wide. With a larger pot size, the stove and 230g Gas canister fits nicely into the pot to save space. 0.8L of the water can be heated during one fill.

Specification

- D** 130 x 130 x 218 mm
- W** 535g
- Cc** One Touch Piezo Ignition
- Ig** 1,500 ml
- F** Iso-Butane (Screw Type Gas Canister)
- C** 90g/h (1,065kcal / 4,225BTU / 1.24kW)
- M** Stainless, Aluminum

Improvement of performance

The newest heat exchange system minimizes heat loss. The Heat Exchange System, designed to stabilize the bottom of the pot, maximizes surface area, minimizing heat loss and maximizing thermal efficiency. Only need 2 mins and 40 secs* to boil 500ml of water.

*Test Condition :
Water temperature of 20 °C in a controlled environment.



All inclusive system

230g gas canister fits nicely into pot to save space.

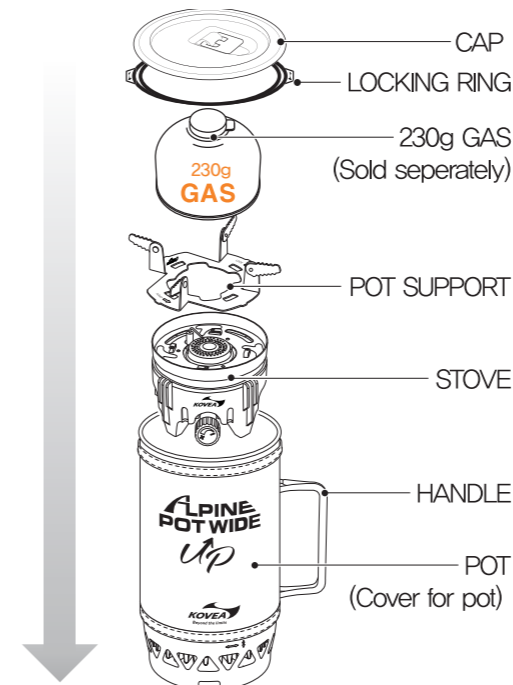

Stove and pot can be detached, compact for hiking and fishing trip.

Can be used as a normal stove with cooker support.



Pot Size

Pot size increased in volume to 1.5L (Safety fill : 0.8L)



Locking ring

Added Locking ring to prevent the damage and for better use.



Compact

Compact storage.



2



GAS STOVE & HEATER

INITIALS

B: Bulb(LED) **Ba**: Battery **C**: Consumption **D**: Dimension **F**: Fuel
M: Material **Q**: Quantity **R**: Runtime **S**: Size **V**: Volume
W: Weight **Br**: Brightness **Cc**: Capacity **Cr**: Color
Fl: Filling **Rg**: Range **St**: Strength **Ig**: Ignition **IL**: illumination

V1

KGB-1607



- D** 70 x 70 x 125mm (Inner Box)
W 80g
F Iso-Butane (Screw Type Gas Canister)
C 193g/h (2,282kcal / 9,062BTU / 2.65kW)

V1 is the most innovative stove. It has regulator which regulate gas pressure so that the flame gets stable. Concaved head with wind shield technology ables to work in high wind situation. It also has lightweight design, ideal for UL backpacking.

SOLO

KB-0409



- D** 57 x 57 x 100mm (Inner Box)
W 124g
F Iso-Butane (Screw Type Gas Canister)
C 137g/h (1,621kcal / 6,434BTU / 1.88kW)

The Solo gas stove is a mini stove that is convenient to carry. Its aluminum flame control valve makes it lightweight. This stove has rotating support legs, an ignition plate installed for maximized ignition, folded configuration capability, and the ability to deliver a powerful flame.

SUPALITE TITANIUM

KB-0707



- D** 65 X 40 X 103mm (Inner Box)
W 56g
F Iso-Butane (Screw Type Gas Canister)
C 162g/h (1,916kcal / 7,605BTU / 2.23kW)

The Supalite Titanium is made of light and durable titanium, making it one of the world's lightest stoves. With its advanced functions, ergonomic designs, and high firepower mechanism, this stove is a must-have item for the outdoors. The specially designed burner head emits strong firepower, and the elaborate adjusting valve makes flame control easy.

HIKER

KB-0408



- D** 96 X 88 X 90mm (Inner Box)
W 232g
F Iso-Butane (Screw Type Gas Canister)
C 148g/h (1,751kcal / 6,948BTU / 2.04kW)

The Hiker gas stove is small but has strong fire power in comparison to the size of the burner head, which evenly distributes firepower. The ignition plate makes lighting easy and maximizes power. A convenient ignition button is built into the lightweight aluminum valve.

POWER NANO

KB-1112



- D** 50 x 50 x 87mm (Inner Box)
W 95g
F Iso-Butane (Screw Type Gas Canister)
C 156g/h (1,845kcal / 7,323BTU / 2.14kW)

The Power Nano stove was designed with the UL backpacker in mind. With the focus on fast boiling times and compactability in mind, this stove is a great addition to any backpackers journey. Tested with a boil time of 2 mins and 23 seconds in the field, this beats any other stove in terms of efficiency and packability. Winner from Gear Institute.com for Best value amongst tested stoves.

TITANIUM

KB-0101



- D** 67 X 38 X 81mm (Inner Box)
W 88g
F Iso-Butane (Screw Type Gas Canister)
C 140g/h (1,656kcal / 6,572BTU / 1.93kW)

This Titanium stove is recommended by outdoor experts. With a specialized burner head, adjustable valve to control fire power and an automatic igniter, this stove meets all your needs.

SCORPION

KB-0410



- D** 98 X 98 X 92mm (Inner Box)
W 163g
F Iso-Butane (Screw Type Gas Canister)
C 133g/h (1,573kcal / 6,246BTU / 1.83kW)

The Scorpion has been tried and tested for many years, one of our popular camping stoves, this stove has an attached windshield that keeps the flame intense and lessens heat loss during cooking or boiling. Added piezo ignition plate to help maximize ignition efficiency and an aluminum valve to reduce the overall weight. Wide pot supports to hold even the heaviest pots and pans for groups and individuals.

BACKPACKERS

TKB-9209-1



- D** 81 X 50 X 100mm (Inner Box)
W 190g
F Iso-Butane (Screw Type Gas Canister)
C 160g/h (1,892kcal / 7,511BTU / 2.2kW)

The Backpackers stove is ultra-light and compact. With durable, rustproof components and an adjustable flame control, this stove is ideal for solo campers. The folding pan supports ease in storage and portability. This signature stove has been around for over 25 years and has been a real trooper during that time.

SCOUT**TKB-8911-1**

- D** 122 X 100 X 125mm (Inner Box)
W 290g
F Iso-Butane (Screw Type Gas Canister)
C 160g/h (1,892kcal / 7,511BTU / 2.2kW)

The Scout is small and compact in size. The head and valve are easy to use. By expanding the auxiliary legs, the stove can safely accommodate a larger container.

FIRE MAN**KB-0808**

- D** 54 X 54 X 100mm (Inner Box)
W 87.5g
F Iso-Butane (Screw Type Gas Canister)
C 150g/h (1,775kcal / 7,511BTU / 2.2kW)

The Fireman literally hoses down the rest of its competition. This UL backpacking stove comes with an aluminum die casting body which significantly reduces its weight, along with adjustable pot supports that bring its folding size to a minimum. The unique spreader pot supports allows the flame to even disperse over the pot or pan during cooking giving an even amount of heat. Great simmering controls for all types of cooking.

FLAME TORNADO**KB-N1005**

- D** 58 X 58 X 96mm (Inner Box)
W 76.7g
F Iso-Butane (Screw Type Gas Canister)
C 160g/h (1,892kcal / 7,511BTU / 2.2kW)

The Flame Tornado with its powerful output of over 7,000 BTUS, helps the UL backpacker when in need of a quick boil. Body made of aluminium die casting, brings down the weight and helps reduce over size with the folding pot supports. A separate piezo ignitor is included so no matches or lighters are required.

(Not available in the United States and European countries, please inquire about availability)

EAGLE**KB-0509**

- D** 57 X 57 X 100mm (Inner Box)
W 105g
F Iso-Butane (Screw Type Gas Canister)
C 128g/h (1,514kcal / 6,012BTU / 1.78kW)

This Eagle stove is ultra-light and compact. It has durable, rustproof components and an adjustable flame control. The folding pan supports ease in storage. This stove is ideal for backpacking, camping and mountaineering.

MAXIMUM**KB-9901**

- D** 93 X 79 X 115mm (Inner Box)
W 267g
F Butane (Nozzle Type Gas Canister)
C 140g/h (1,656kcal / 6,574BTU / 1.92kW)

The Maximum is in a class of its own, this very unique designed stove is ideal for those who want to do more than just boil water outdoors. This stove was designed for use with the 220g nozzle type gas canisters. An easy to install mechanism allows this stove to be used in an instant. Our patented 1 touch adaptor optimizes the ease of use. Made of aluminium it is very lightweight compared to the other gas ranges that use this type of gas.

CAMP 1 PLUS**KGB-1608**

- D** 140 x 90 x 145mm (Inner Box)
W 360g
F Iso-Butane (Screw Type Gas Canister)
C 140g/h (1,656kcal / 6,572BTU / 1.93kW)

The Camp One Plus is an upgraded version of our most trusted stove, we increased its power to reduce boil time and keep wind from being a factor.

The main body and wind shield can be detached which allows for easier cleaning. It also has a heating pipe which helps during colder temperatures and increases fuel efficiency.

GAS STOVE & HEATER

HYDRA

KGB-1305



- D** 297 X 266 X 97mm (Inner Box)
W 310g
F White gasoline, Iso-Butane (Screw Type Gas Canister)
C White gasoline 209ml/h (1,860kcal / 7,380BTU / 2.16kW)
 Iso-Butane 131g/h (1,550kcal / 6,150BTU / 1.8kW)

Most innovative product yet.

Not only is this stove both Iso Butane and White Gasoline compatible, but you don't have to change any nozzles when switching fuels. Designed to prime the fuel before it reaches the head, this stove drastically reduces the noise where others have failed.

BOOSTER DUALMAX

KB-N0810



- D** 125 X 90 X 68mm
W 340g
F White gasoline, Iso-Butane (Screw Type Gas Canister)
C White gasoline 246ml/h (2,184kcal / 8,666BTU / 2.54kW)
 Iso-Butane 123g/h (1,455kcal / 5,774BTU / 1.69kW)

The Booster Dual Max has foldable legs to support the pot safely, saving volume for better storage and portability. The air shutter controls the oxygen rate depending on different fuels. The stove head has direct flame holes.

The separate nozzle cleaning pin is included to aid in clogging maintenance after use.

MOONWALKER

KB-0211G



- D** 118 X 103 X 92mm (Inner Box)
W 291g
F Iso-Butane (Screw Type Gas Canister)
C 140g/h (1,656kcal / 6,572BTU / 1.93kW)

The Moonwalker has a double wall pipe, anti-flare system design doubly preventing cumbersome liquefaction. Its foldable legs allow for stability and compact storage. This stove uses a small flame control, making it more lightweight. The gas heating systems directs the gas pipe to pass through the stove, keeping it warm and efficient in colder temperatures.

EXPEDITION

TKB-N9703



- D** 140 X 90 X 145mm (Inner Box)
W 397g
F Iso-Butane (Screw Type Gas Canister)
 Butane (Nozzle Type Gas Canister)
C 140g/h (1,656kcal / 6,572BTU / 1.93kW)

The Expedition has a double-pipe, anti-flare system to prevent liquefaction and gas flaring. The ignition plate makes ignition easy and maximizes power, as wind breakers operate the pot supports. Foldable legs provide stable support for larger cooking pans. This stove is especially durable with its fluorine hose and stainless rustproof components.

BOOSTER+1

KB-0603



- D** 367 X 266 X 97mm (Inner Box)
W 315g
F White gasoline, Iso-Butane (Screw Type Gas Canister)
C White gasoline 274ml/h (3,068kcal / 12,179BTU / 3.55kW)
 Iso-Butane 195g/h (2,307kcal / 9,154BTU / 2.68kW)

The Booster+1 with its powerful output have the best of both worlds with the versatile and easy-to-operate Booster+1 stove. Use either butane gas or white gasoline, without exchanging nozzles. The pot supports and legs are connected by an ingenious gearing system which allow them to fold and unfold simultaneously. Best used all year round in any weather.

CAMP 5

KB-1006



- D** 58 X 58 X 127mm (Inner Box)
W 156g
F Iso-Butane (Screw Type Gas Canister)
C 146g/h (1,725kcal / 6,857BTU / 2.00kW)

This Camp-5 stove prevents liquefaction by using copper pipes. The flame is highly efficient and is concentrated in the center. Pot supporter and legs move simultaneously and comfortably to accommodate various types.

SPIDER

KB-1109

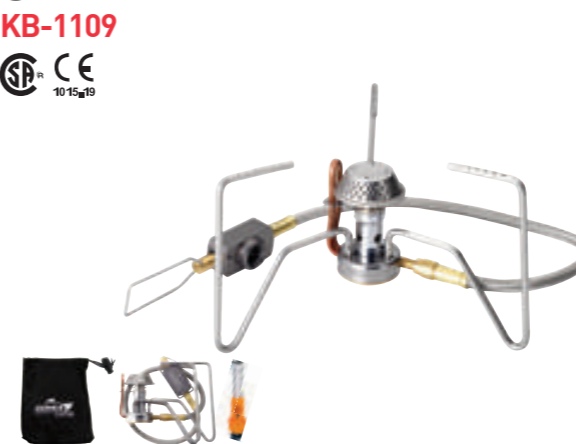

- D** 93 X 45 X 105mm (Inner Box)
W 168g
F Iso-Butane (Screw Type Gas Canister)
C 120g/h (1,420kcal / 5,633BTU / 1.65kW)

The Spider is one of our best-selling stoves. It has an anti-flame system pipe that provides a powerful and stable flame. The foldable pan support legs and lower balance enhances the stove's safety.

DUAL FLAME

KGB-1302



- D** 112 X 77 X 147mm (Inner Box)
W 228g
F Iso-Butane (Screw Type Gas Canister)
C 140g/h (1,656kcal / 6,572BTU / 1.93kW)

The Dual Flame has a very unique flame head design which emits 2 different flames on a larger burner head. This large flame base in 2 different directions is ideal for the backpacker / camper who wants to do more than just boil water. An even flame dispersion does not burn the pot / pan in one area and allows for an even cooking surface.

ALPINE MASTER

KGB-1701



- D** 178 X 178 X 213mm (Inner Box)
W 883g
F Iso-Butane (Screw Type Gas Canister)
C 162g/h (1,916kcal / 7,605BTU / 2.23kW)
Cc 2,000ml

The Alpine master has a new Surface Combusting System and Heat Exchange System which allows for greater heating and fuel efficiency with faster boiling times. Allows one to carry all the cooking components in one system, even the gas canister. Ideal for outdoor activities such as fishing, camping, and backpacking.

ALPINE POT WIDE UP

KB-0703WU



- D** 130 x 130 x 218mm
W 535g
F Iso-Butane (Screw Type Gas Canister)
C 90g/h (1,065kcal / 4,225BTU / 1.24kW)
Cc 1,500ml

The Alpine Pot Wide Up is an upgraded version of our Alpine Pot Wide. With a larger pot size, the stove and 230g Gas canister fits nicely into the pot to save space. 0.8L of water can be heated during one fill.

SLIM TWIN STOVE LITE

KGB-1312A



- x 2ea Butane Adapter
 x 2ea Propane Adapter

- D** 542 X 340 X 72mm (Inner Box)
W 4,9kg
F Iso-Butane (Screw Type Gas Canister), Propane Gas, Butane (Nozzle Type Gas Canister)
C Iso-Butane 230g/h (2,721kcal / 10,797BTU / 3.22kW)
 Propane 316g/h (3,738kcal / 14,842BTU / 4.34kW)
 Butane 201g/h (2,378kcal / 9,436BTU / 2.76kW)

The Slim Twin Stove Lite is a derived product from the original Slim Twin stove. The Gas canister can be directly connected to the bottom of the stove. The height has been adjusted for use with different fuel canisters. The most versatile 2 Burner stove on the market. Never have to worry about what fuel to use.

SLIM TWIN STOVE

KGB-1312



- D** 542 x 340 x 72mm (Inner Box)
W 5kg
F Iso-Butane (Screw Type Gas Canister)
C 230g/h (2,721kcal / 10,797BTU / 3.22kW)

The Slim Twin Stove is as compact and innovative as it gets. The sleek design saves tons of space and the dual hose regulator valves allows the stove to be used in any weather conditions.

ALPINE POT EZ-ECO

KGB-1410



ESPO
AWARD
GOLD
WINNER
2015



- D** 130 X 130 X 200mm (Inner Box)
W 770g
F Butane & Iso-Butane (Refillable gas tank)
C 51.3g/h (607kcal / 2,410BTU / 0.7kW)
Cc 1,100ml (gas capacity : 27g)

The Alpine Pot EZ Eco is exactly what you see. An Alpine Pot stove system with the fuss of carrying a fuel canister. This new innovative system has a built in fuel base which allows you to fill it with gas before you go out on your trip, no more fuss of taking the fuel with you for those short 1 day hikes. A pot without the fuel canister saves space and weight and can boil 500 ML of water up to 6 times on 1 full charge. An adapter is included for use of both nozzle type and screw type gas canister.

ALPINE POT WIDE

KB-0703W



1015a19



- D** 130 X 130 X 175mm (Inner Box)
W 510g
F Iso-Butane (Screw Type Gas Canister)
C 75g/h (887kcal / 3,521BTU / 1.02kW)
Cc 1,100ml

The Alpine Pot Wide is a great stove system to carry with you on your next excursion. It comes with a wide based 1 L pot and a couple of attachments where you can actually cook with the stove. A cozy is attached to the pot to prevent burns when the pot is in use and the handles are coated with a silicon to help grip the pot. 0.5 L of water can be heated during one fill.

DELUXE TWIN STOVE

KGB-9401 (Yellow)
 KGB-9401B (Black)
 KGB-9401W (White)

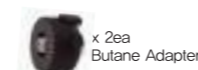

x 2ea Butane Adapter



- D** 490 X 110 X 298mm (Inner Box)
W 4kg
F Iso-Butane (Screw Type Gas Canister)
C 162g/h (1,916kcal / 7,608BTU / 2.2kW)

The Deluxe Twin Stove is the GO TO stove when it comes to car camping. This stove is ideal for families and groups of campers who need the twin burner head for some serious cooking. Equipped with a windshield, it makes cooking in the outdoors simple and fun. With the new color additions people will turn heads at the campsite when they see it.

An adapter is included for use of 220g nozzle type gas canister.



MINI
KGG-1805



Ability to store the lid and bowl in the body of the stove.

The bottom of the main body of the ceramic pan, designed to prevent the pan from moving around while not in use.



D 318 x 275 x 117mm (Inner Box)
W 1.9kg
F Butane (Nozzle Type Gas Canister)
C 110g/h (1,301kcal / 5,162BTU / 1.51kW)

Gas grill with designed with a vintage retro look.
 Various cooking accessories are available with pot support.
 The lid can also be used as a food tray.

GAS STOVE & HEATER



ALL IN ONE GAS BBQ (M)
KG-0904PM

ALL IN ONE GAS BBQ (L)
KGG-1304



D 430 X 212 X 238mm (Inner Box)
W 3.73kg
F Butane (Nozzle Type Gas Canister)
C 169g/h (1,999kcal / 7,937BTU / 2.32kW)

D 535 X 185 X 310mm (Inner Box)
W 5.5kg
F Butane (Nozzle Type Gas Canister)
C 185g/h (2,461kcal / 9,769BTU / 2.85kW)

The All in One Gas BBQ is the perfect companion for all types of cooking indoor or outdoor. This is the all in one cooking stove that does everything you ever need, personalized to fit on a table perfect for grilling, cooking stews, shabu shabu, fondue, kebabs, you name it. It comes equipped with 3 different types of cooking trays and has a unique U shaped flame head to evenly distribute heat and flame throughout the pan. Take this portable cooking stove anywhere you want to cook and not worry about how to cook but what to cook.

CUBE

KGR-1503

CE
1015#19



- D** 223 X 195 X 105mm (Inner Box)
- W** 750g
- F** Butane (Nozzle Type Gas Canister)
- C** 130g/h (1,538kcal / 6,105BTU / 1.78kW)

The Cube is a newly designed table top stove that is stylish and compact. This freshly designed stove is ideal for picnics and home parties. It works with nozzle type gas canisters and is compact for when you need to keep more than 1 pot going.

COOKING PLUS RANGE

KR-2109-D



- D** 330 X 102 X 310mm (Inner Box)
- W** 1,5kg
- F** Butane (Nozzle Type Gas Canister)
- C** 210g/h (2,484kcal / 9,863BTU / 2.88kW)

The Cooking Plus is your go to table top stove. Allows you to use easy accessible butane canister while enjoying food at home or while on a picnic or even camping. Ideal for those times when you want to cook soup.

TORNADO

KGR-1701



- D** 320 X 280 X 95mm (Inner Box)
- W** 2.1kg
- F** Butane (Nozzle Type Gas Canister)
- C** 170g/h (2,011kcal / 7,985BTU / 2.33kW)

Heat efficiency is far great with the tornado effect
The integrated windshield is also suitable for outdoor activities.

PICNIC RANGE

KGR-3500



- D** 326 X 277 X 91mm (Inner Box)
- W** 1,5kg
- F** Butane (Nozzle Type Gas Canister)
- C** 200g/h (2,366kcal / 9,395BTU / 2.75kW)

Portable gas stove perfect for picnics and outdoor activities

BEETLE RANGE

KR-2005-1



- D** 223 X 195 X 105mm (Inner Box)
- W** 750g
- F** Butane (Nozzle Type Gas Canister)
- C** 130g/h (1,538kcal / 6,105BTU / 1.78kW)

The Beetle gas range is a convenient portable and compact item that is not available anywhere else. This is easy to carry and enables one to use during any outdoor activity. The Auto gas shut off regulator is installed to improve the safety of the overall product. Its one touch piezo ignition system makes it easy to light and use.

ALUMINIUM RANGE

KR-2102



- D** 330 X 102 X 310mm (Inner Box)
- W** 1,5kg
- F** Butane (Nozzle Type Gas Canister)
- C** 210g/h (2,484kcal / 9,863BTU / 2.88kW)

The Aluminium table top stove is stylish and great for use while in the outdoors and can also be used a functions where simmering something is needed. Great way to keep everyone happy with a hot dish while eating.

PORTABLE

TKR-9507



- D** 343 X 275 X 85mm (Inner Box)
- W** 2.0kg
- F** Butane (Nozzle Type Gas Canister)
- C** 140g/h (1,656kcal / 6,575BTU / 1.92kW)

The Portable table top stove is great when you need a stable cooker while eating, great for use during multiple cooking situations and also sturdy enough to use almost anywhere.

PORTABLE PROPANE

TKR-9507-P



- D** 376 X 318 X 98mm (Inner Box)
- W** 1,8kg
- F** Propane (Propane Gas Canister)
- C** 150g/h (1,800kcal / 7,146BTU / 2.1kW)

The Portable Propane table top stove is ideal for any type of picnic function, you can use this for large parties and long time use as it is directly hooked up to the propane tank.

HANDY SUN

KGH-1609



- D** 158 x 158 x 195mm
- W** 197g
- F** Iso-Butane (Screw Type Gas Canister)
- C** 60g/h (710kcal / 2,817BTU / 0.82kW)

The Handy Sun is our newest, smallest and lightest heater in our product line. This small heater is great for trips where it gets a bit cold and you need something to warm you up.

CUPID

KH-1203



- D** 175 X 140 X 270mm (Inner Box)
- W** 1.4kg
- F** Butane (Nozzle Type Gas Canister)
- C** 71g/h (840kcal / 3,333BTU / 0.98kW)

The Cupid heater is ideal for those camping trips where it may get a little chilly at night. This heater emits a strong amount of heat from its ceramic heating pad and is small enough to carry around for those 2 person camping trips.

FIREBALL

KH-0710



- D** 190 X 180 X 190mm (Inner Box)
- W** 565g
- F** Iso-Butane (Screw Type Gas Canister)
- C** 66g/h (781kcal / 3,100BTU / 0.91kW)

The Fireball has a hose-type gas canister connection for ease and safety. The mesh based heating system provides radial heat for the camper / backpacker. The heating pipe helps to stabilize the firepower and the large bulb increases power. The reflector turns 45 degrees for added convenience. Heating pipe attached to the output to allow for better gas efficiency. Hose type gas canister connection allows for easy access to gas valve.

GIGA SUN

KGH-1310



- D** 385 X 385 X 580mm (Inner Box)
- W** 6kg
- F** Propane Gas
- C** 500g/h (6,000kcal / 23,800BTU / 6.97kW)

The Giga Sun Heater has a distinct yet modern look of an old circular furnace, where instead of coal or wood, the gas emits heat in a 360-degree radius. It has a built in safety feature that automatically shuts itself off if it tilts or tips over, or when carbon monoxide levels gets too high. Great for camping and overlanding with its great power, zcompact size compared to other rotary heaters available on the market.

POWER SENSE

KH-2006



- D** 255 X 227 X 245mm (Inner Box)
- W** 1.4kg
- F** Butane (Nozzle Type Gas Canister)
- C** 75g/h (887kcal / 3,522BTU / 1.03kW)

The Power Sense heater is perfect for those times when you need heat to warm yourself up, whether it be in the garage or on the patio, it emits enough heat to keep you nice and toasty.

LITTLE SUN

KH-0203



- D** 275 X 190 X 320mm (Inner Box)
- W** 2.1kg
- F** Butane (Nozzle Type Gas Canister)
- C** 120g/h (1,420kcal / 5,636BTU / 1.65kW)

The Little Sun name says it all. This heater emits a heat via its ceramic plate and can be used in the garage or on your patio. Great for keeping you warm in places where heat is not accessible.

3

GAS - LED LANTERN

INITIALS

B: Bulb(LED) **Ba**: Battery **C**: Consumption **D**: Dimension **F**: Fuel
M: Material **Q**: Quantity **R**: Runtime **S**: Size **V**: Volume
W: Weight **Br**: Brightness **Cc**: Capacity **Cr**: Color
Fl: Filling **Rg**: Range **St**: Strength **Ig**: Ignition **IL**: Illumination

FIREFLY

KL-805



1299 08



- D** 73 X 69 X 107mm (Inner Box)
- W** 146g
- Ig** Manual
- F** Iso-Butane (Screw Type Gas Canister)
- C** 32g/h (379kcal / 1,503BTU / 0.44kW)
- IL** 40Lux

Compact and bright for those backpackers looking to reduce weight. Simple and functional in design. Finite control handle to increase fuel efficiency and control brightness.

HELIOS

KL-2905



1299 11



- D** 69 X 69 X 143mm (Inner Box)
- W** 267g
- Ig** One Touch Piezo Type
- F** Iso-Butane (Screw Type Gas Canister)
- C** 51g/h (603kcal / 2,395BTU / 0.70kW)
- IL** 90Lux

Anti Corrosion ceramic coated lid for longer usage. Reflecting shade to increase light illumination radius. Convenient piezo ignitor for easy lighting.

GENTLEMAN

KGL-1403



GOD DESIGN



- D** 163 X 163 X 221mm (Inner Box)
- W** 267g
- Ig** One Touch Piezo Type
- F** Iso-Butane (Screw Type Gas Canister)
- C** 80g/h (946kcal / 3,756BTU / 1.1kW)
- IL** 250Lux

Medium sized powerful lantern to help creating special atmosphere. Downward facing flame holes to keep the brightness to a maximum. Double layered mesh holes used to decrease noise.

MINI POST

KA-1008



- D** 29,5 x 280mm
- W** 50g
- M** Aluminium
- Cr** Orange

Wider and effective light condition when use on the table. No gas leak when installing / removing the product with double valve system. Easier to install/remove a gas canister.

OBSERVER

KL-103



1299 08



- D** 63 X 63 X 113mm (Inner Box)
- W** 168g
- Ig** One Touch Piezo Type
- F** Iso-Butane (Screw Type Gas Canister)
- C** 38g/h (450kcal / 1,785BTU / 0.52kW)
- IL** 35Lux

Compact and bright for those backpackers looking to reduce weight. Finite control handle to increase fuel efficiency and control brightness. Piezo ignitor included for convenience.

SOUL

TKL-4319



- D** 129 X 129 X 180mm (Inner Box)
- W** 450g
- Ig** One Touch Piezo Type
- F** Iso-Butane (Screw Type Gas Canister)
- C** 53g/h (627kcal / 2,489BTU / 0.73kW)
- IL** 60Lux

Strong structure and design for the everyday backpacker. Reflecting shade to increase light illumination radius. Convenient piezo ignitor for easy lighting.

MANTLE



APPLICATION MODEL

- KL-103
- KL-805
- KL-K805
- TKL-929
- KL-2905



APPLICATION MODEL

- KL-2901
- TKL-961
- KL-1010
- KGL-1403

GLOBE



APPLICATION MODEL

- KL-103
- KL-805
- KL-K805
- KL-2905



APPLICATION MODEL

- TKL-929
- TKL-4319
- TKL-961
- KL-2901

MESH



APPLICATION MODEL

- KL-103
- KL-805
- KL-K805



APPLICATION MODEL

- TKL-961
- KL-2901

BLACK LEO
KBL-1702



- D 66 X 55 X 80mm (Blister)
- W 50g (Including Battery)
- Br 200Lm / 80Lm / 40 Lm
- B CREE XT-E
- Ba AAA Alkaline x 3EA
- R High 5hr / Med 12hr / Low 45hr

MERCURY 2
KECU9LH-01



- D 62 X 46 X 40mm (Blister)
- W 88g (Including Battery)
- Br 200Lm / 100Lm / 20Lm
- B 1 x 3W Gen 2 LG White LED
- Ba AAA Alkaline x 3EA
- R High 7hr / Med 14hr / Low 95hr

HALLY 1000
KBL-1800



- D 32 X 32 X 146mm (Blister)
- W 130g
- Br 1000Lm
- B 1 CREE XPL 2 10W LED
- Ba 18650/Li-on BATTERY (Rechargeable Battery)
- R High 2hr

SPOT
KECU9LH-03



- D 58 X 43 X 27mm (Blister)
- W 90g (Including Batteries)
- Br 1 x 3W Gen 2 LG White LED
- B 60Lm / 200Lm / 4Lm / 6Lm
- Ba AAA Alkaline x 3EA
- R High 5hr / Mid 10hr / Low 120hr / High(RED) 30hr

L-CORE RECHARGEABLE LANTERN II
KN8LT0302



- D 205 X 58 X 45mm
- W 272g
- Br 600Lm
- B CRI80
- R High: 4.5hr / Low: 48hr
- Cr White

WORK LIGHT
KBL-1805



- D 225 x 58 x 45mm
- W 170g
- Br Main 240Lm / Assist 100Lm
- B Main 3W COB LED / Assis 1W LED
- Ba AA Alkaline x 3EA
- R Main 5hr / Assis 10hr



4

TORCH & BARBECUE GRILL



Mark Instruction

BUTANE Suitable for butane gas

LIGHTER Suitable for lighter gas

PROPANE Suitable for propane gas

ISO BUTANE Suitable for iso-butane gas

360° 360° rotatable

Hand icon Auto piezo ignition

INITIALS

B: Bulb(LED) **Ba**: Battery **C**: Consumption **D**: Dimension **F**: Fuel
M: Material **Q**: Quantity **R**: Runtime **S**: Size **V**: Volume
W: Weight **Br**: Brightness **Cc**: Capacity **Cr**: Color
Fl: Filling **Rg**: Range **St**: Strength **Ig**: Ignition **IL**: illumination



OCTA
KGT-1808



D 140 X 41 X 200mm (Blister Pad)
W 93g
Ig One Touch Piezo Type
F Butane (Nozzle Type Gas Canister)
C 105g/h (1,242kcal / 4,928BTU / 1.4kW)

COOK MATE
KT-1209



D 168 X 94 X 52mm
W 180g
Ig One Touch Piezo Type
F Butane (Nozzle Type Gas Canister)
C 106g/h (1,270kcal / 5,042BTU / 1.48kW)

HESTIA
KT-2603



D 122 X 56 X 220mm
W 253g
Ig One Touch Piezo Type
F Butane (Nozzle Type Gas Canister)
C 106g/h (1,270kcal / 5,042BTU / 1.48kW)

MULTI PURPOSE
TKT-9607



D 140 X 43 X 200mm
W 142g
Ig One Touch Piezo Type
F Butane (Nozzle Type Gas Canister)
C 80g/h (960kcal / 3,811BTU / 1.10kW)

FIRE Z
KGT-1406



D 187 X 38 X 60mm
W 144g
Ig One Touch Piezo Type
F Butane (Nozzle Type Gas Canister)
C 130g/h (1,538kcal / 6,105BTU / 1.78kW)

COOK MASTER
KGT-1408



D 231 X 99 X 61mm (Inner Box)
W 162g
Ig One Touch Piezo Type
F Butane Gas (Nozzle Type Gas Canister), Lighter Gas
C 105g/h (1,242kcal / 4,930BTU / 1.44kW)

FIRE BIRD
KT-2511



D 231 X 99 X 61mm (Inner Box)
W 162g
Ig One Touch Piezo Type
F Butane (Nozzle Type Gas Canister)
C 105g/h (1,242kcal / 4,930BTU / 1.44kW)

PHOENIX
KT-2709-H



D 157 X 51 X 45mm
W 126g
Ig One Touch Piezo Type
F Butane (Nozzle Type Gas Canister)
C 80g/h (960kcal / 3,811BTU / 1.10kW)



PHANTOM
KGT-1405

x 2ea
Butane Adapter



D 80 X 55 X 622mm
W 405g
Ig One Touch Piezo Type
F Iso-Butane (Screw Type Gas Canister),
Butane (Nozzle Type Gas Canister)
C 490g/h (5,796kcal / 23,003BTU / 6.74kW)

MASTER
KT-2211



D 162 X 38 X 60mm
W 135g
Ig One Touch Piezo Type
F Butane (Nozzle Type Gas Canister)
C 80g/h (960kcal / 3,811BTU / 1.10kW)

NEW MICRO
KT-N2301



D 116,5 X 39 X 68mm
W 122g
Ig One Touch Piezo Type
F Butane (Nozzle Type Gas Canister), Lighter Gas Canister
C 15g/h (180kcal / 715BTU / 0.2kW)

FREE NECK
KT-2924



D 200 X 310 X 46mm
W 180g
Ig One Touch Piezo Type
F Butane (Nozzle Type Gas Canister)
C 120g/h (1,440kcal / 5,717BTU / 1.68kW)

CYCLONE - Butane
KT-2904



D 227 X 153 X 46mm
W 134g
Ig One Touch Piezo Type
F Butane (Nozzle Type Gas Canister)
C 120g/h (1,440kcal / 5,717BTU / 1.68kW)

BRAZING 1
KT-2104



D 125 X 40 X 255mm
W 125g
Ig Manual
F Butane (Nozzle Type Gas Canister)
C 120g/h (1,440kcal / 5,717BTU / 1.68kW)

BRAZING 2
KT-2504



BUTANE

D 125 X 40 X 255mm
W 125g
Ig Manual
F Butane (Nozzle Type Gas Canister)
C 120g/h (1,440kcal / 5,717BTU / 1.68kW)

ROCKET
KT-2008-1



BUTANE

D 240 X 39 X 80mm
W 126g
Ig Manual
F Butane (Nozzle Type Gas Canister)
C 258g/h (3,100kcal / 12,307BTU / 3.6kW)

BLAZER
KT-1306



PROPANE 360°

D 191 X 28 X 398mm
W 345g
Ig One Touch Piezo Type
F Propane (Propane Gas Canister)
C 168g/h (2,016kcal / 8,004BTU / 2.34kW)

HECATON
KT-2610



PROPANE 360°

D 150 X 53 X 315mm
W 460g
Ig One Touch Piezo Type
F Propane (Propane Gas Canister)
C 168g/h (2,016kcal / 8,004BTU / 2.34kW)

TWIN BRAZING
KT-2108



BUTANE

D 130 X 40 X 290mm
W 173g
Ig Manual
F Butane (Nozzle Type Gas Canister)
C 234g/h (2,808kcal / 11,148BTU / 3.26kW)

CANON
KT-2408



BUTANE 360°

D 117 X 40 X 250mm
W 235g
Ig Manual
F Butane (Nozzle Type Gas Canister)
C 300g/h (3,600kcal / 14,292BTU / 4.2kW)

PROPANE TWIN BRAZING
KT-2910



PROPANE

D 130 X 40 X 290mm
W 201g
Ig Manual
F Propane (Propane Gas Canister)
C 384g/h (4,608kcal / 18,294BTU / 5.35kW)

PROPANE CYCLONE
KTS-2906



PROPANE

D 153 x 45 x 227mm (Blister Pad)
W 200g
Ig One Touch Piezo Type
F Propane (Propane Gas Canister)
C 168g/h (1,987kcal / 7,890BTU / 2.34kW)



INFERNO TORCH KPT-1510

Heat output is far greater than any torch on the market and does not require an oxygen supply device at the time of welding. BRAZING TIP can be interchanged to be a single or dual torch. Rotates 360 degrees.



- D 125 X 40 X 255mm
- W 125g
- Ig Manual
- F Propane (Propane Gas Canister)
- C 120g/h (1,440kcal / 5,717BTU / 1.68kW)



KOT BASIC KGT-1704



- D 170 x 105 x 126mm (Inner Box)
- W 510g
- Ig One Touch Piezo Type
- F Butane (Nozzle Type Gas Canister)
- C 21g/h (248kcal / 986BTU / 0.28kW)

METAL GAS PEN KTS-2402



- D 79 x 25 x 119mm (Blister Pad)
- W 50g
- Ig Manual
- F Lighter Gas Canister / Fuel tank capacity 9ml (5g)
- C 10g/h (118kcal / 469BTU / 0.13kW)

HOSE PEN TORCH KT-2202



- D 135 x 40 x 260mm (Blister Pad)
- W 200g
- Ig One Touch Piezo Type
- F Butane (Nozzle Type Gas Canister)
- C 8g/h (94kcal / 375BTU / 0.11kW)

DOLPHIN KTS-2907



- D 175 x 75 x 265mm (Blister Pad)
- W 142g
- Ig One Touch Piezo Type
- F Lighter Gas Canister / Fuel tank capacity 16ml (9g)
- C 16g/h (189kcal / 751BTU / 0.22kW)



MAGIC I UPGRADE STAINLESS BBQ KCG-0712



D 360 X 50 X 200mm (Inner Box)
W 1,83kg

The Magic I is a very compact BBQ grill perfect for small groups, you can take this anywhere with its nice carry bag and stainless steel frame. It folds and unfolds nicely and stores away in small spaces.

MAGIC II UPGRADE STAINLESS BBQ KCG-0901

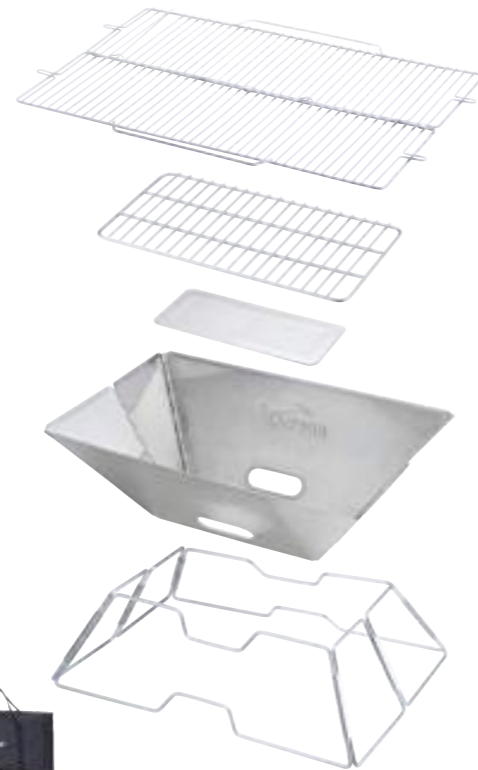

D 500 X 20 X 200mm (Inner Box)
W 2,5kg

The Magic II is a very compact BBQ grill perfect for bigger groups, you can take this anywhere with its nice carry bag and stainless steel frame. It folds and unfolds nicely and stores away in small spaces.

MAGIC III UPGRADE STAINLESS BBQ KCG-1503



D 470 X 60 X 275mm (Inner Box)
W 4,7kg

The Magic III is a new addition to the already wide range of compact and portable BBQ grills. This larger addition is great for family picnics anywhere you go. Whether it be at the beach or tailgating at the game, its perfect for cooking on the go.

TORCH & BARBECUE GRILL



5



COOKWARE & ACCESSORY

INITIALS

B: Bulb(LED) **Ba**: Battery **C**: Consumption **D**: Dimension **F**: Fuel
M: Material **Q**: Quantity **R**: Runtime **S**: Size **V**: Volume
W: Weight **Br**: Brightness **Cc**: Capacity **Cr**: Color
Fl: Filling **Rg**: Range **St**: Strength **Ig**: Ignition **IL**: illumination

SOLO LITE
KCW-SL12



D 50 x 150 x 125mm (Inner Box)
W 370g (Incl. stowing bag)
M Aluminium
Cc 1~2 Persons

D 176 X 116 X 40mm (Inner Box)
W 60g
F Iso-Butane (Screw Type Gas Canister)
C 162g/h (1,916kcal / 7,605BTU / 2.23kW)



SOLO 3
KSK-SOL03



D 165 X 165 X 115mm (Inner Box)
W 650g (Incl. stowing bag)
M Aluminium
Cc 1~2 Persons

D 176 X 116 X 40mm (Inner Box)
W 60g
F Iso-Butane (Screw Type Gas Canister)
C 162g/h (1,916kcal / 7,605BTU / 2.23kW)



HARD 23
KSK-WH23



D 185 X 185 X 137mm (Inner Box)
W 814g (Incl. stowing bag)
M Aluminium
Cc 2~3 Persons

HARD 78
KSK-WH78



D 217 X 217 X 195mm (Inner Box)
W 2,3kg (Incl. stowing bag)
M Aluminium / pp
Cc 7~8 Persons

SOLO 2
KSK-SOL02



D 50 x 150 x 125mm (Inner Box)
W 370g (Incl. stowing bag)
M Aluminium
Cc 1~2 Persons

ESCAPE
VKK-ES01



D 150 X 150 X 160mm (Inner Box)
W 511g (Incl. stowing bag)
M Aluminium / pp
Cc 1~2 Persons

HARD 56
KSK-WH56



D 207 X 207 X 175mm (Inner Box)
W 1.5kg (Incl. stowing bag)
M Aluminium / pp
Cc 5~6 Persons

HARD COOKWARE 10
KSK-WH10



D 255 X 255 X 251mm (Inner Box)
W 3,6kg (Incl. stowing bag)
M Aluminium / pp
Cc 10 Persons

SILVER 56
KSK-WY56



D 207 X 207 X 175mm (Inner Box)
W 1,04kg (Incl. stowing bag)
M Aluminium / pp
Cc 5~6 Persons

CAMPING SPOON SET
KKW-1002



D 154 X 225 X 23mm (Blister)
W 45g
M Stainless

SILVER 78
KSK-WY78



D 217 X 217 X 210mm (Inner Box)
W 2,12kg (Incl. stowing bag)
F Aluminium / pp
Cc 5~6 Persons

CUTLERY SET
KKW-1504



D 102 X 94 X 213mm (Inner Box)
W 423g
M Stainless

BLACK STONE DYNAMIC
KDW-0500BD
KDW-0750BD
KDW-1000BD



D 500ml – 74 x 74 x 258mm (Inner Box)
750ml – 87 x 87 x 300mm (Inner Box)
1000ml – 89 x 89 x 321mm (Inner Box)
M Stainless / PP / ABS / Silicon

Thermal effect 500ml – 40°C
750ml – 44°C
1000ml – 50°C

Soft Touch
The exterior is a Matte finish which allows for a comfortable grip.

One Touch Stopper
Easy to open lid with just one hand.

Detachable Stopper
Stopper is detachable into 2 parts, allowing for easier cleaning. Turn the stoppers upper part clockwise to detach.

18-9 Stainless Steel
Both inner and outer parts use 18/8 Stainless Steel which is resistant to corrosion and discoloration

Getter System Vacuum Wall & Copper Coating
Getter system of creating a vacuum seal between 2 stainless steel walls with a copper coating which effectively blocks heat transfer or radiant heat allowing for longer thermal use.



MEGA HOT
KDW-MH1000
KDW-MH1200
KDW-MH1500



D 1000ml – 120 X 110 X 242mm (Inner Box)
1200ml – 120 X 110 X 277mm (Inner Box)
1500ml – 120 X 110 X 322mm (Inner Box)
M Stainless / PP / ABS / Silicon

Thermal effect 1000ml – 44°C
1200ml – 49°C
1500ml – 52°C

ADAPTOR

KA-N9504

D Ø40 X H30mm
W 47g



LPG ADAPTOR LIGHT

KGA-1610

D Ø29,9 X H35,2mm
W 32,8g



2 WAY ADAPTOR

KA-2105

D Ø40 X H30mm
W 47g



COBRA GAS ADAPTOR

KA-0103

D 90 X 91 X 61mm
W 141g



IGNITER

KI-1007

D 20,5 X 81mm
W 13,2g



KB-0603 PUMP



KB-0603 HEAD



KB-0211G HEAD



KB-0101 HEAD



P-ADAPTOR

KA-1004

D 90 X 91 X 61mm
W 141g



LPG ADAPTOR

VA-AD-0701

D 28 X 30 X 40mm
W 105g



PAT ADAPTOR

KA-2004

D Ø60 X H30mm
W 71g



CAP HEATER

KH-0811

D Ø76 X H88mm
M Chrome Mash / Stainless Grill



WIND SHEILD

KW-0101



D 85 X 240 X 30mm (Inner Box)
W 150g

POCKET WARMER

VKH-PW04S
VKH-PW05M
VKH-PW06L



D 58×13,5×95mm
68 X 15 X100mm
70×21×111mm
W 60g / 88g / 113g

NOZZLE TYPE GAS 220g

KGF-0220



SCREW TYPE GAS 110g · 230g · 450g

KGF-0110
KGF-0230
KGF-0450



FUEL BOTTLE

KPB-0600
KPB-1000



6



CAMPING & ETC.

INITIALS

B: Bulb(LED) **Ba**: Battery **C**: Consumption **D**: Dimension **F**: Fuel
M: Material **Q**: Quantity **R**: Runtime **S**: Size **V**: Volume
W: Weight **Br**: Brightness **Cc**: Capacity **Cr**: Color
Fl: Filling **Rg**: Range **St**: Strength **Ig**: Ignition **IL**: illumination

RIVER SIDE 1**KECV9TD-06**

- D** Fly – 170 x 215 x 110cm
Inner tent – 100 x 215 x 110cm
- W** 3.5 kg
- M** Body – Polyester
(75D Poly Taffeta, Water Pressure 1,500mm, PU, W/P, W/R)
- Inner tent – Polyester (650D Poly Taffeta, W/R)
Floor – Polyester (1500D Poly Oxford, W/R)
Pole – Fiber glass 8,5Ø(MAIN)
- Cc** 1 person

RIVER SIDE 2**KECU9TD-03**

- D** Fly – 290 x 240 x 110cm
Inner tent – 220 x 140 x 100cm
Ground sheet – 210 x 130cm
- W** 4.1 kg
- M** Polyester
(75D Poly Taffeta, Water Pressure 1,500mm, PU, W/P, W/R)
- Pole – Fiber glass 9,5Ø(MAIN)
Fiber glass 11Ø(CENTER)
- Cc** 2 persons

RIVER SIDE 4**KECU9TD-03**

- D** Fly – 410 x 240 x 145cm
Inner tent – 240 x 220 x 135cm
Ground sheet – 230 x 210cm
- W** 6.3 kg
- M** Body – Polyester (75D Poly Taffeta, Water Pressure 1,500mm, PU, W/P, W/R)
- Inner tent – Polyester (650D Poly Taffeta, W/R)
Floor – Polyester (1500D Poly Oxford, W/R)
Ground sheet – Polyethylene
Pole – Fiber glass 9,5Ø(MAIN)
Fiber glass 11Ø(CENTER)
- Cc** 4 persons

TOURING CAR SHELTER**KECT9TW-03**

- D** Fly – 470 X 280 X 200cm
Inner tent – 250 X 210 X 180cm
Ground sheet – 240 X 200cm
- W** 12kg
- M** Polyester
(75D Poly Taffeta, Water pressure 2,000mm, PU, W/P, W/R, FR)
- POLE – Fiber glass 11Ø
Up light po : ST. 19Ø
- Cc** 4 persons

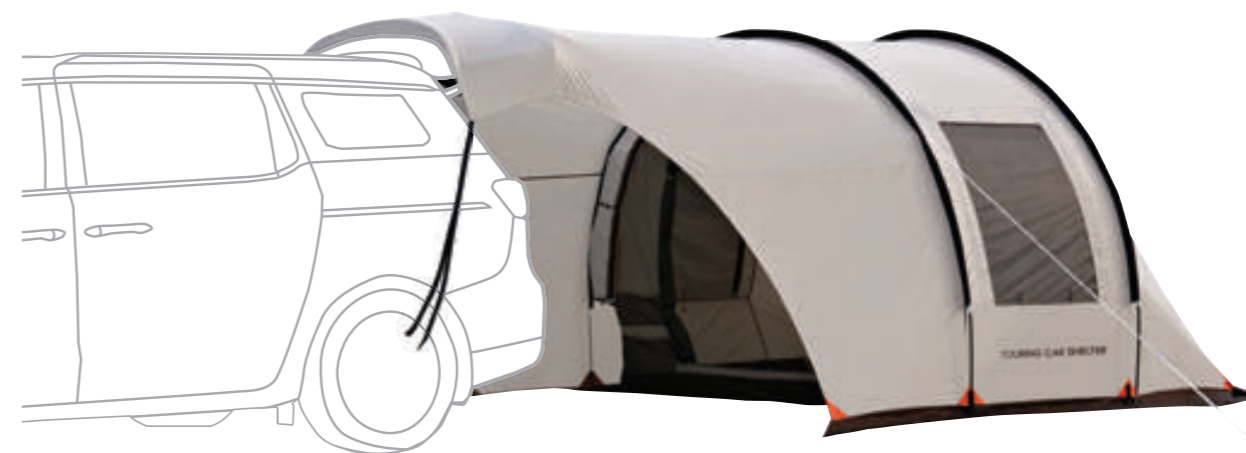
**WOW FAMILY UP****KECT9TI-03**

- D** Fly – 290 X 241 X 113cm
Inner tent – 222 X 235 X 103cm
- W** 6.2 kg
- M** Body – Polyester
(75D Poly Taffeta, Water Pressure 3,000mm, PU, W/P, W/R)
- Inner tent – Polyester (68D Poly Taffeta, B/R, W/R)
Floor – Polyester (1500D Poly Oxford, W/R)
Pole – Fiber glass 6,9Ø(MAIN)
- Cc** 3 persons





Precise coupling using holes



linking tables with connectors

SYSTEM TABLE A
KECU9FE-01



- D** 71 x 46 x 70(55/30)cm
71 x 46 x 3.5cm(When store)
- W** 3kg
- M** Frame – Aluminium
Plate – Aluminium(Hot Moving Coating)

SYSTEM TABLE B
KECU9FE-02



- D** 71 x 46 x 70(55/30)cm , 71 x 46 x 3.5cm(When store)
Plate – 36 x 27cm
- W** 3.3kg
- M** Frame – Aluminium
Plate – Aluminium(Hot Moving Coating)

SLIM 4 FOLDING BBQ TABLE II
KECV9FA-07



- D** 160 x 80 x 70(55/30)cm
80 x 40 x 8.5cm (When store)
61 x 38cm (Plate)
- W** 10kg
- M** Plate – Aluminium(Hot Moving Coating)
Frame – Aluminium
Plate – Steel

⊕ Sold Separately



SLIM S/4 FOLDING BBQ TABLE CARRY BAG
KECT9BT-02

SLIM 3 FOLDING BBQ TABLE II
KECV9FA-06



- D** 120 x 80 x 70(55/30)cm
80 x 40 x 8cm (When store)
61 x 38cm (Plate)
- W** 7.5kg
- M** Plate – Aluminium(Hot Moving Coating)
Frame – Aluminium
Plate – Steel

⊕ Sold Separately



SLIM S/4 FOLDING BBQ TABLE CARRY BAG
KECT9BT-02

SLIM 3 FOLDING TABLE II
KECV9FA-05



- D** 120 x 80 x 70(55/30)cm
80 x 40 x 7cm (When store)
- W** 6.5kg
- M** Plate – Aluminium(Hot Moving Coating)
Frame – Aluminium

⊕ Sold Separately



SLIM S/4 FOLDING BBQ TABLE CARRY BAG
KECT9BT-02

AL 2 FOLDING TABLE II
KECV9FA-04



⊕ Sold Separately



2 FOLDING TABLE CARRY BAG
KECT9BT-02 (KJCA0114)

- D** 120 x 60 x 70(55/30)cm
60 x 60 x 6.5cm (When store)
- W** 5kg
- M** Plate – Aluminium(Hot Moving Coating)
Frame – Aluminium

AL BAMBOO ONE ACTION TABLE (L)
KECS9FB-03



⊕ Sold Separately
BAMBOO ONE ACTION TABLE (L) CARRY BAG
KECN9BT-03 (KN8CE0111)

- D** 100 x 65 x 70(55/42)cm
65 x 10 x 50cm (When store)
- W** 8,2kg
- M** Plate – Bamboo
Frame – Aluminium

AL ONE ACTION TABLE S
KECV9FA-06



The one action feature allows the legs to automatically fold out when opening to use. The legs then fold in towards the table while having 2 different levels of height.

- D** 90 x 50 x 70(55/30)cm
47 x 41 x 6.6cm (When store)
- W** 4kg
- M** Plate – Aluminium(Hot Moving Coating)
Frame – Aluminium

AL BAMBOO ONE ACTION TABLE (M)
KECS9FB-02



⊕ Sold Separately
BAMBOO ONE ACTION TABLE (M) CARRY BAG
KECN9BT-02 (KN8CE0110)

- D** 80 x 50 x 70(55/42)cm
50 x 10 x 49.8cm (When store)
- W** 5,8 kg
- M** Plate – Bamboo
Frame – Aluminium

LIGHT TABLE S
KECU9FF-01



- D** 500 x 360 x 285(55/30)mm
100 x 100 x 360mm(When store)
- W** 610g
- M** Plate, Case – Polyester(600D Poly Oxford)
Frame – Aluminium

LIGHT TABLE M
KECU9FF-02



- D** 600 x 410 x 285(55/30)mm
100 x 100 x 420mm(When store)
- W** 720g
- M** Plate, Case – Polyester(600D Poly Oxford)
Frame – Aluminium

AL BAMBOO ONE ACTION KITCHEN TABLE II
KECU9FB-01



⊕ Sold Separately
BAMBOO ONE ACTION KITCHEN TABLE CARRY BAG
KECN9BT-04 (KN8CE0112)

- D** 100 x 65 x 70(55/42)cm
65 x 10 x 50cm (When store)
- W** 8,2kg
- M** Plate – Bamboo
Frame – Aluminium



FIELD LUXURY CHAIR II**KECU9CA-08**

- D** 63 x 73 x 96cm
15 x 20 x 115cm (When store)
35cm (Seat height)
- W** 4.5kg
- M** Seat – Polyester(600D Poly Oxford)
Frame – Aluminium
- Cr** Ivory, Khaki

RELAX COZY CHAIR M**KECV9CA-02**

- D** 60 x 50 x 71cm
11 x 12 x 86cm (When store)
35cm (Seat height)
- W** 2.3kg
- M** Seat – Polyester(600D Poly Oxford)
Frame – Aluminium
- Cr** Light olive, Navy

FIELD RELAX LONG CHAIR II**KECU9CA-01**

- D** 58 x 70 x 100cm
15 x 16 x 117cm (When store)
35cm (Seat height)
- W** 3kg
- M** Seat – Polyester(600D Poly Oxford)
Frame – Aluminium
- Cr** Blue, Orange

VIVID CHAIR II**KECV9CA-05**

- D** 53 x 58 x 67.5cm
14 x 12 x 36cm (When store)
30cm (Seat height)
- W** 1.2kg
- M** Seat – Polyester(600D Poly Oxford)
Frame – Aluminium
- Cr** Khaki, Tan

LAYBACK CHAIR III**KECU9CS-03**

- D** 62 x 72 x 103cm
14 x 15 x 117cm (When store)
38cm (Seat height)
- W** 4.7kg
- M** Seat – Polyester(600D Poly Oxford)
Frame – Aluminium
- Cr** Blue, Gray

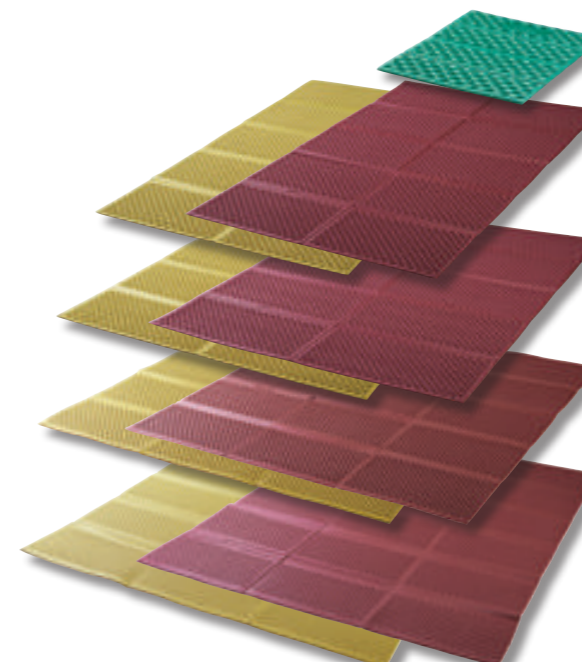
**MINI CUSION MF8MA0101**

- D** 31 x 38cm / 31 x 10 x 12cm (Packed in a bag)
- W** 170g

CAMP MAT 120 KS8MA0101

- D** 120 x 200cm / 60 x 40 x 12cm (Packed in a bag)
- W** 730g

CAMP MAT 160 KS8MA0102

- D** 160 x 200cm / 80 x 40 x 12cm (Packed in a bag)
- W** 1.1kg

CAMP MAT 200 KR8MA0104

- D** 197 x 200cm / 60 x 40 x 18cm (Packed in a bag)
- W** 1.5kg

CAMP MAT 260 KS8MA0104

- D** 260 x 200cm / 67 x 47 x 19cm (Packed in a bag)
- W** 1.9kg



KOMFY 400 - 600

KSB-1807
KSB-1808



- D 400 : 190 x 73cm
600 : 195 x 85cm
- W 400 : 850g
600 : 1,23kg
- M Shell – Polyester 65D 185ST W/R Cie
Lining – Polyester 65D 190T Pongee
- FI Polyester Padding 600gm
Polyester Hollow padding 400gm

STAINLESS ZIPSIN 6

KEMS9HE-01



- D 230~245mm(S)
250~265mm(M)
270~285mm(L)
- W 320g(S) / 328g(M) / 340g(L)
- Cr Orange(S) / Green(M) / Blue(L)

RESCUE BAG

KM8CE0102

*Rescue kits are not included



- D 17 x 14.5 x 5cm
- W 9.8kg
- M 1680D Polyester, E.V.A

COMODO

KCM-1804



- D 235 x 70cm (Before)
190 x 58 x 5 cm (After)
- W 480g
- M 20D Nylon TPU

COY

KCM-1803



- D 243 x 71cm (Before)
190 x 58 x 5 cm (After)
- W 480g
- M 20D Nylon TPU

MARINO

KCM-1802



- D 238 x 70cm (Before)
190 x 60 x 3 cm (After)
- W 275g
- M 20D Nylon TPU

FREE TRACK GOLD SPATS II

KM9EI0102



- D 240~270mm / L : 260~290mm
- W 253g(M) / 273g(L)
- M Nylon(Taslan 3Layer), Wire(4mm), Hypalon(1mm)
Polyester(600D Polyester, Oxford DTY, WR, PU 3time)
- Cr Red(M) / BLUE(L)

EMERGENCY BLANKET

KN8AM0102



- D 220 x 140cm
- W 52g

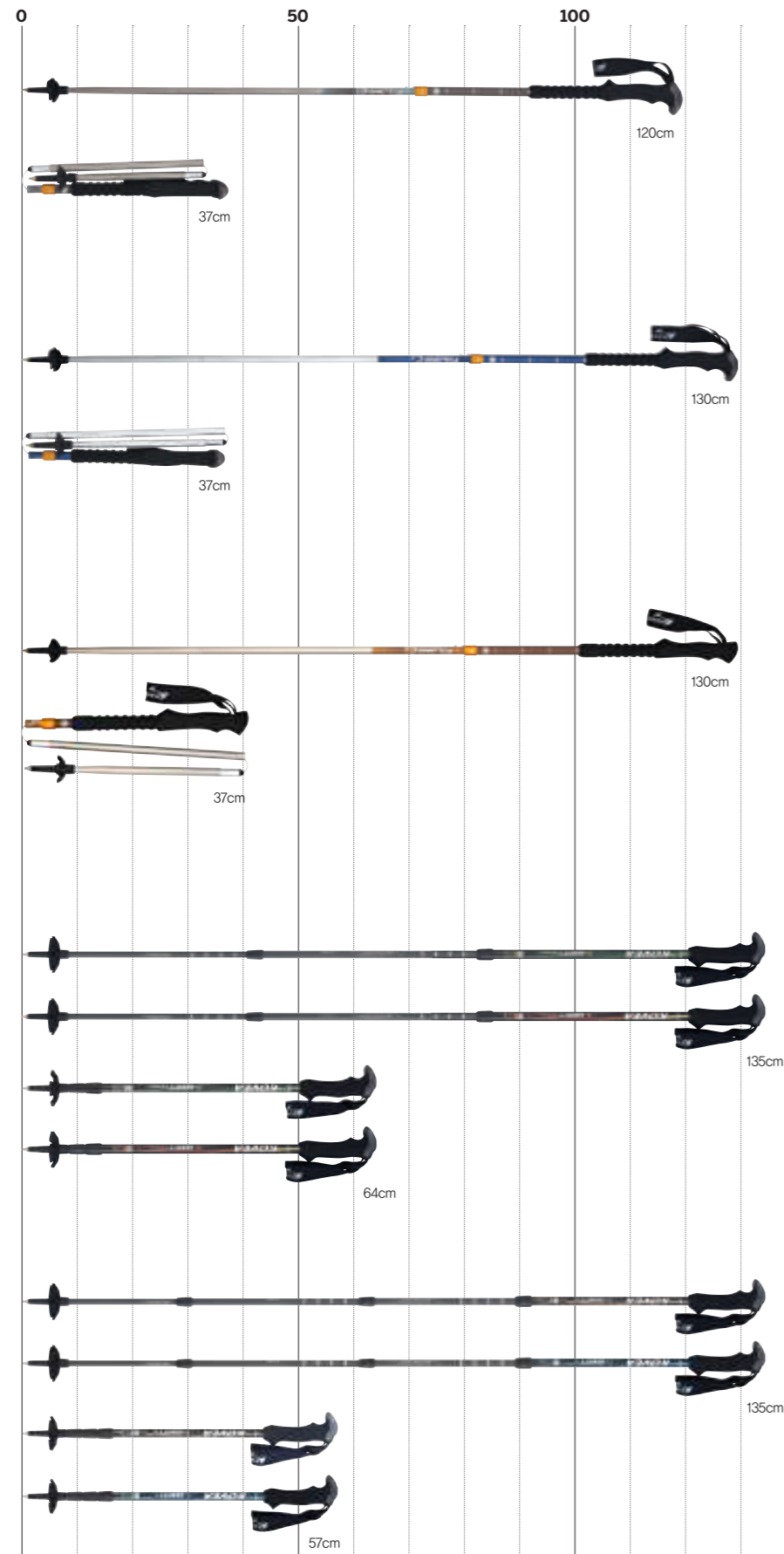

NEW
FOLDING C1
KS8ST0101
 DURALUMIN
 239g / 3Levels

NEW
FOLDING C2
KS8ST0102
 DURALUMIN
 249g / 3Levels

NEW
FOLDING C3
KEMU9MD-01
 DURALUMIN
 269g / 3Levels

NEW
Z-GRAVITY III
KM8ST0101
 CARBON
 184g / 3Levels
 Cr Green, Brown

NEW
Z-GRAVITY IV
KM8ST0102
 CARBON
 191g / 4Levels
 Cr Brown, Blue

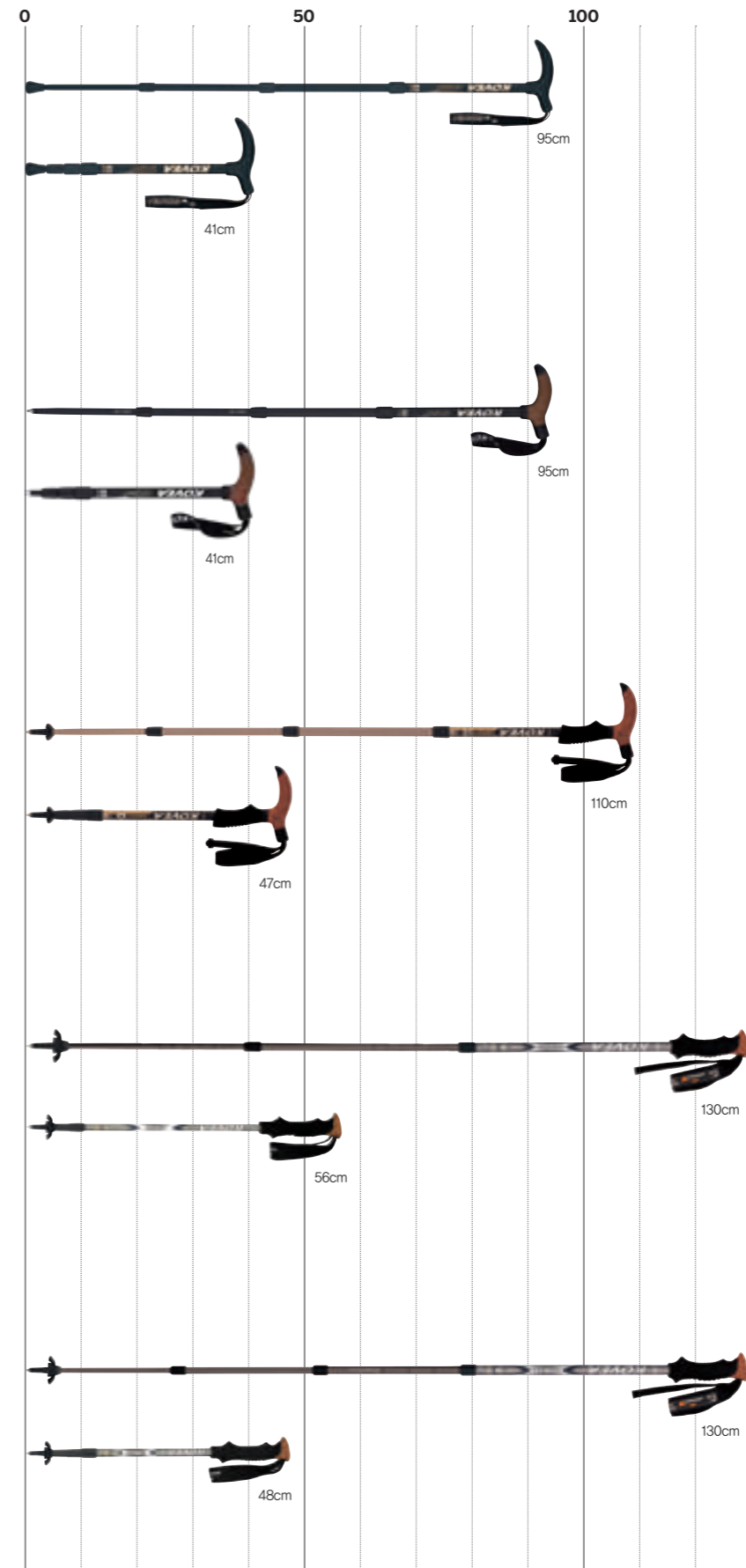

**WILD
 SHORTCUT 2**
VKS-306
 DURALUMIN
 225g / 4Levels

**WILD
 SHORTCUT 2
 (CORK)**
VKS-306C
 DURALUMIN
 225g / 4Levels

SHORTCUT 2
KH8ST0201
 DURALUMIN
 260g / 4Levels

**STORM
 HOLD III**
KI8ST0103
 DURALUMIN
 190g / 3Levels

**STORM
 HOLD IV**
KI8ST0105
 DURALUMIN
 215g / 4Levels

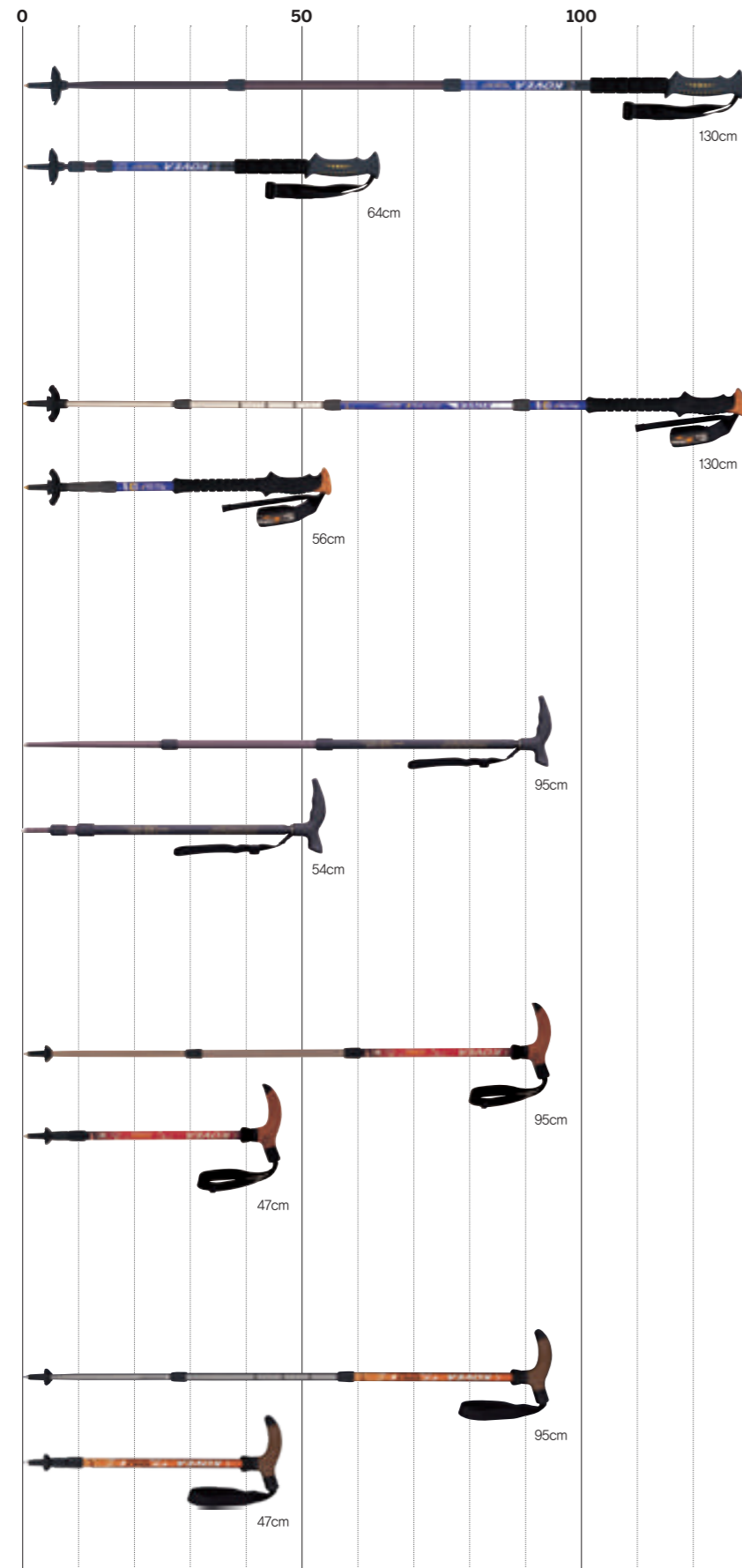

BLUE SKY
VKS-N2005
 DURALUMIN
 270g / 3Levels

BLUE SKY II
KH8ST0101
 DURALUMIN
 260g / 4Levels

CLASSIC
KZ8ST0205
 DURALUMIN
 210g / 3Levels

TERA
VK-T501
 DURALUMIN
 205g / 3Levels

MIRAGE
VK-T506
 DURALUMIN
 205g / 3Levels

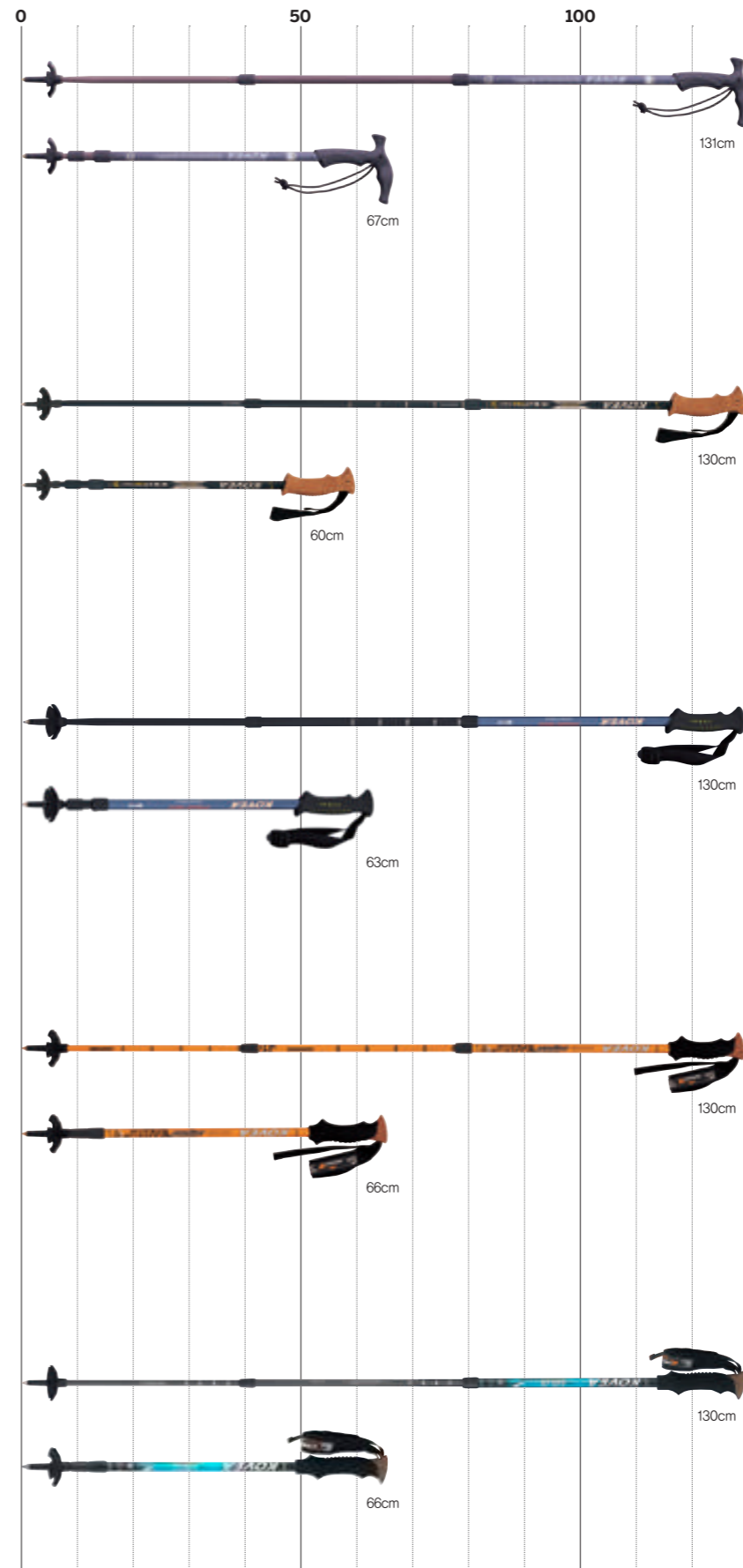

CROSS ACTION
VKS-N9606
 DURALUMIN
 270g / 3Levels

WILD CORK 4000
KE8ST0111
 DURALUMIN
 270g / 3Levels

DREAM WALK
VKS-N9604
 DURALUMIN
 270g / 3Levels

JAGUAR
KH8ST0101
 DURALUMIN
 245g / 3Levels

SOLID
KI8ST0104
 DURALUMIN
 245g / 3Levels

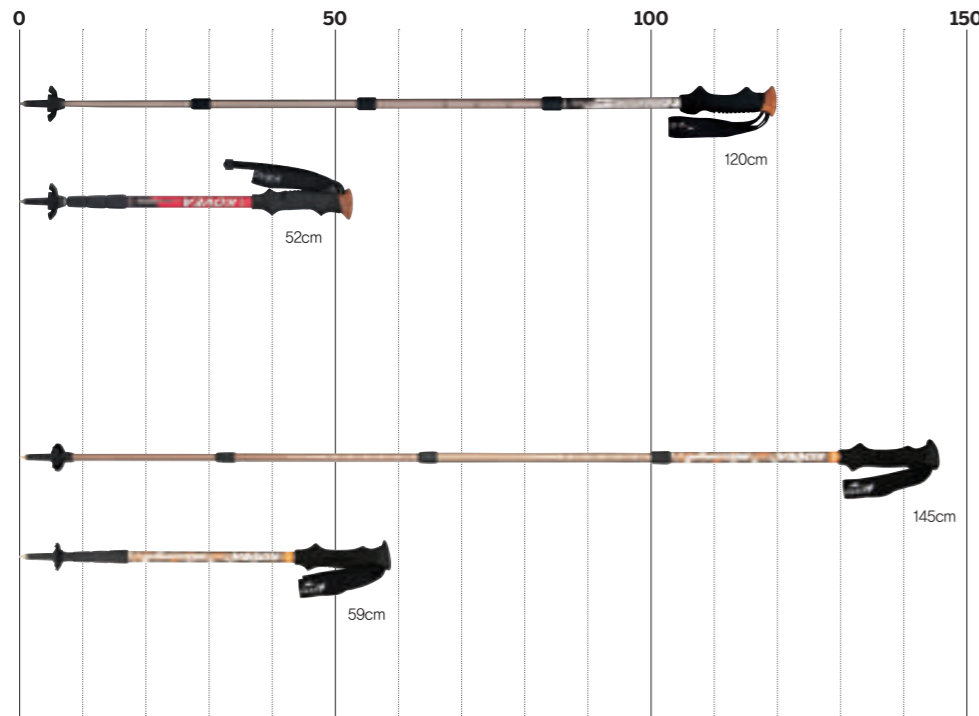

STONE
KG8ST0107
 DURALUMIN
 245g / 4Levels

CAMP GUARD
KEMT9MD-01
 DURALUMIN
 250g / 4Levels

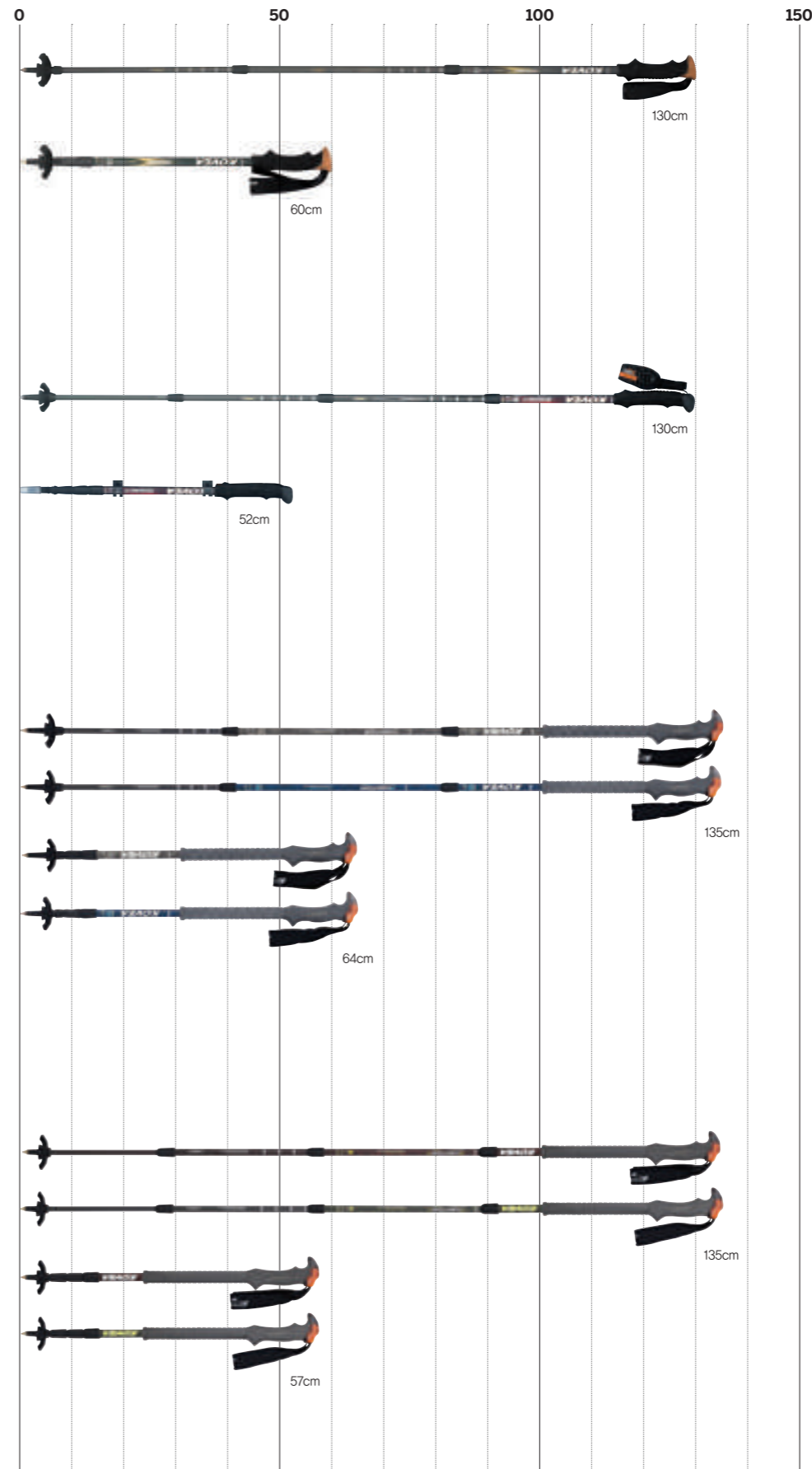

DYNAMIC III
KI8ST0104
 Al. CARBON
 180g / 3Levels

NEW DYNAMIC IV
KI8ST0104
 Al. CARBON
 210g / 4Levels

PHANTOM III
KM8ST0103
 Al. CARBON
 216.5g / 3Levels
 Cr Brown, Blue

PHANTOM IV
KM8ST0104
 Al. CARBON
 230g / 4Levels
 Cr Red, Green

INSTRUCTION OF USING POLES

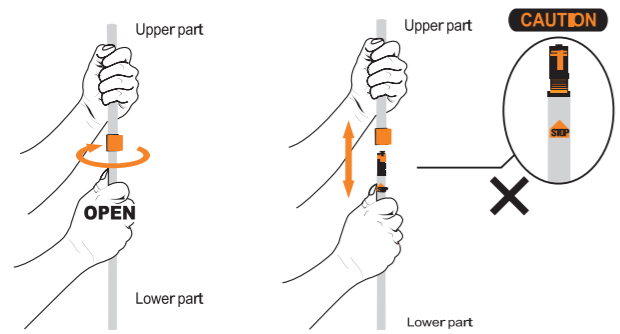

PRODUCT FOR PROFESSIONAL
 a. Hold the upper and lower part, turn clockwise and pull.
 b. Do not pull or fasten past the "STOP" mark. Doing so may damage the pole.

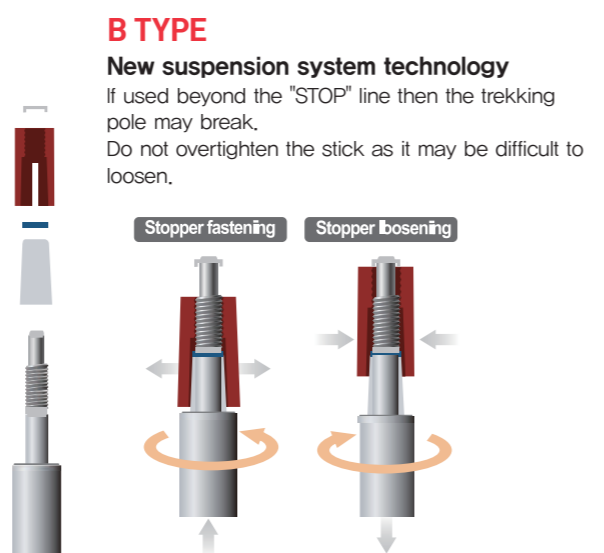
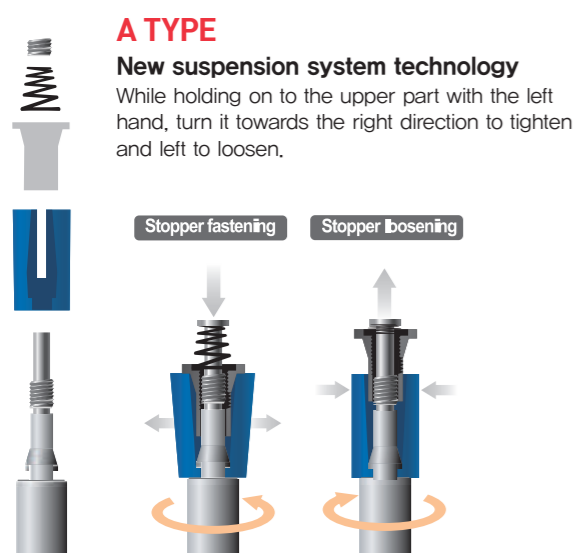

8



TRANGO CONTENTS

INITIALS

B: Bulb(LED) **C**: Consumption **D**: Dimension **F**: Fuel
M: Material **Q**: Quantity **R**: Runtime **S**: Size **V**: Volume
W: Weight **Br**: Brightness **Cc**: Capacity **Cr**: Color
Fl: Filling **Rg**: Range **St**: Strength **Ig**: Ignition **IL**: Illumination

S4 CAM

S4-0.5~4



S4 CAM SET

(Oval K St Carabiner included)

M AL7075
Rg 10.5~14.5 / 13~18 / 16~22.5 / 19.5~28.5 / 25~35.5 mm
W 54 / 61 / 63 / 71 / 76 g
St 7 / 7 / 10 / 10 / 10 kN

4 Cam structure, but the two cams are designed symmetrically so that the entire cam is able to install safely in small cracks, not deep cracks.

NEW FLEX

TNF-01~09



M (TNF-01~04) AL7075 / (TNF-05~09) AL6061
Rg 10~17 / 13~21 / 17~27 / 20~33 / 26~44 / 33~55 / 42~69 / 53~86 / 65~107 mm
W 58 / 60 / 73 / 81 / 121 / 128 / 148 / 182 / 233 g
St 7 / 7 / 10 / 10 / 12 / 12 / 12 / 12 / 12 kN

Each of the left and right cams are installed symmetrically, but each cam is moved individually, so that it is possible to stably install the cams in various irregular cracks.

BALLNUTZ

TBN-01~05



BALLNUTZ SET

(Oval K St Carabiner included)

M STS304
Rg 3.7~6.4 / 4.8~9.0 / 6.1~11.6 / 7.8~13.8 / 10.3~17.5 mm
W 31 / 39 / 49 / 58 / 73 g
St 7 / 8 / 8 / 8 / 8 kN

Five sizes (3.7mm ~ 17.5mm) are convenient for fine cracks that are difficult to install with a normal friend product.

CALM HMS TRIPLE LOCK
TCHK-T02



M AL7075
D 114 x 74 mm
W 93 g
St Major 27 kN / Minor 8 kN / Open 7 kN

CALM HMS LOCK
TCHK-02



M AL7075
D 114 x 74 mm
W 88 g
St Major 27 kN / Minor 8 kN / Open 7 kN

HMS K LOCK
TCHK-01



M AL7075
D 120 x 75 mm
W 92 g
St Major 27 kN / Minor 8 kN / Open 7 kN



MIGHTY K LOCK
TCHK-30



M AL7075
D 112 x 72 mm
W 76 g
St Major 30 kN / Minor 9 kN / Open 8 kN



HMS TRIPLE K LOCK
TCHK-T01



M AL7075
D 112 x 73 mm
W 83 g
St Major 24 kN / Minor 8 kN / Open 8 kN



MD K LOCK / MD K BT / MD K ST
TCDK-01 / TCDK-02 / TCDK-03

M AL7075
D 100 x 55 mm
W 54 / 48 / 48 g
St Major 26 kN / Minor 8 kN / Open 7 kN



BEAK K LOCK / BEAK K BT / BEAK K ST
TCDK-14 / TCDK-15 / TCDK-16

M AL7075
D 101 x 58 mm
W 51 / 45 / 45 g
St Major 24 kN / Minor 8 kN / Open 8 kN



BEAM K LOCK / BEAM K BT / BEAM K ST
TCDK-13 / TCDK-09 / TCDK-10

M AL7075
D 98 x 57 mm
W 46 / 41 / 41 g
St Major 24 kN / Minor 8 kN / Open 8 kN

MD W/ST
TCD-06



M AL7075
D 99 x 56 mm
W 43 g
St Major 24 kN / Minor 8 kN / Open 7 kN

BEAM W/BT / BEAM W/ST
TCD-11 / TCD-12



M AL7075
D 98 x 57 mm
W 34 g
St Major 25 kN / Minor 8 kN / Open 9 kN

SPINE W/BT / SPINE W/ST
TCD-13 / TCD-14



M AL7075
D 90 x 53 mm
W 30 g
St Major 24 kN / Minor 8 kN / Open 8 kN



TINY TRIPLE LOCK / TINY LOCK / TINY ST
TCOK-T01 / TCOK-03 / TCOK-04

M AL7075
D 98 x 61 mm
W 71 / 66 / 59 g
St Major 24 kN / Minor 8 kN / Open 7 kN



OVAL K LOCK / OVAL K ST
TCOK-02 / TCOK-01

M AL7075
D 107 x 60 mm
W 73 / 66 g
St Major 24 kN / Minor 8 kN / Open 7 kN



BIG D K LOCK / BIG D K ST
TCDK-08 / TCDK-07

M AL7075
D 115 x 67 mm
W 75 / 69 g
St Major 28 kN / Minor 8 kN / Open 7 kN



SPINE 6 PACK
TC-S6-01

M AL7075
D 90 x 53 mm
W 30 g
St Major 24 kN / Minor 8 kN / Open 8 kN



SOX STEEL LOCK
TCOK-S02

M SCM435
D 108 x 61 mm
W 183 g
St Major 30 kN / Minor 15 kN / Open 10 kN



QUICK LINK ST08
TCQ-ST08

M STS316
D 75 x 40 mm
W 79 g
St Major 40 kN / Minor 10 kN

QUICKDRAW SET



TOUGH QUICKDRAW SET K 12 / 17
TAG-TSK-12 / TAG-TSK-17

M Nylon 66 + AL7075
D Webbing Length – 12 / 17 cm, Webbing Width – 25 mm
W 117 g / 123 g
St 22 kN



DYNEEMA QUICKDRAW SET K 12 / 17
TAG-11DSK-12 / TAG-11DSK-17

M Dyneema + AL7075
D Webbing Length – 12 / 17 mm, Webbing Width – 12 mm
W 102 g / 108 g
St 22 kN

BEAM W/QUICKDRAW SET 12 / 17
TAG-WS-12 / TAG-WS-17

M Dyneema + AL7075
D Webbing Length – 12 / 17 mm, Webbing Width – 12 mm
W 74 g / 80 g
St 22 kN

SPINE W/QUICKDRAW SET 12 / 17
TAG-SP-12 / TAG-SP-17

M Dyneema + AL7075
D Webbing Length – 12 / 17 mm, Webbing Width – 12 mm
W 66 g / 72 g
St 22 kN



QUICKLINK QUICKDRAW SET 17 / 30 / 60
TAG-QS-17 / TAG-QS-30 / TAG-QS-60

M STS 316 + Nylon 66 + AL7075
D Webbing Length – 17 / 30 / 60 mm, Webbing Width – 25 / 15 / 15 mm
W 146 g / 149 g / 166 g
St 22 kN

TOUGH BIND
TAG-B25



QUICKDRAW BIND
TAG-B12



TOUGH QUICKDRAW SLING 12/17
TAG-11D-12 / TAG-11D-17 / TAG-11D-22



DYNEEMA QUICKDRAW SLING 12/17/22
TAG-T12 / TAG-T17



ASCENDER
TAG-09L / TAG-09R



M AL7075 + EPDM + STS420J2 + Elastomer
Rg 8~13 mm
W 208 g
St 4 kN

Rope catches with excellent braking force securely hold back rope, and rope catch holes prevent objects (ice, dust, etc.) from sticking on the rope.

MOOR
TAG-03



M AL6061
Rg ① ≥9 mm, ② ≥8.3 mm, ③ ≥7.8 mm
W 69 g

Versatile belaying device that is possible to belay the lead and second climber, and utilize the automatic braking function to the second climber.

FIGURE 8
TAG-01-1



M AL7075
Rg ① 8.6~12 mm, ② 7.9~8.6 mm
W 140 g
St 40 kN

Fluid appearance and outstanding tensile strength and durability.

ASCENDER & PULLY & BELAY DEVICE

LIGERO
TPG-IR-01



M AL
Rg ① ≤12 mm
W 90 g
St 22 kN

Pulley with fixed side plates and ball bearings for high efficiency.

VERGO
28622



M AL + STS
Rg ① 8.9~10.7 mm
W 195 g

Vergo is the self-braking system by the pulling force of the rope. The part where the rope is braked is small so there is no damage on the rope and smoothly feeded.

PYRAMID
TAG-02



M AL2024
Rg ① 8.9~12 mm, ② 8~11mm
W 70 g

Small and light belay device which has outstanding durability.

RAPTOR

TIT-1008



M 17-4PH + SCM435 + AL7075 + EPDM
D 49 cm
W 598 g (643 g with weight)

This ice tool is for advanced climber for high level ice climbing and competition.

NEW SCORPION

TIT-16



M STS420J2 + SCM435 + AL7075 + EPDM
D 52 cm
W 660 g

Manufactured harmonize-curved shape shaft, pick angle and different thickness of pick tip provide best performance.



RAPID 12 / 17 / 22

TIPT-IS-12/ 17/ 22

M STS420 + AL7075
D 12 cm / 17 cm / 22 cm
W 133 g / 161 g / 182 g

The drill-shaped sawtooth design assure users to install and the aluminum hanger has reduced weight.



ALPINIST PICKEL 70 / 75 / 80 / 85 / 90

TIP-01-70~90

M SCM435 + AL7075
D 70 cm / 75 cm / 80 cm / 85 cm / 90 cm
W 640 g / 650 g / 660 g / 670 g / 680 g

Can be used for overseas expedition, deep snow, and climbing of a snowy wall.

HYPER GUIDE

TIC-05



M SCM435
S Free
W 1,280 g

Hinged type crampons that allow flexible movement by connecting the front and rear axes to the frame and are divided into left and right.

HYPER HARPOON X-CROSS 6 PEAK

TIC-06

KE-0210



M SCM435
S Free
W 1,110 g

Suitable crampon for intermediate or high level climber at hard ice and mix climbing.



M S50C
S Free
W 492 g

For maximize comfort, apply X-Cross webbing which designed for stabilize while long term use. (Registration of utility model : No. 299027, Registration design : No. 334303)



ICE TOOL CASE

TITA-17-1



DOUBLE ICE TOOL CASE

TITA-20



RAPTOR WEIGHT

TITA-16



MONO POINT KIT

TICA-03



RAPTOR PICK

TITA-15



HEEL BINDING

TICA-04



NEW SCORPION PICK

TITA-14



CRAMPON STRAPS

TICA-01



PICK COVER

TITA-18



CRAMPON CASE

TICA-05



LEASH

TITA-01

SICURO

THG-12



- M** ABS
S 53~62 cm
W 364 g
Cr Mustard, Cyan, Red

ABS material SHELL is robust and absorbs shock.

The stereoscopic shape memory headband has soft touch and does not sweat thanks to embossing treatment.

There are ventilation vents and dial type size adjusters on the left and right sides.

It has excellent durability and can be used for various purposes such as winter climbing, expedition climbing, structure, industrial safety and caving.

COMET

THG-11



- M** PC + EPS
S 53~64 cm
W 300 g
Cr Darkgray, Orange

It is first product with sunglasses inside the helmet in the world.

ZENITH

THG-10



- M** PC + EPS
S 53~64 cm
W 265 g
Cr Gray, Green, Yellow

Very fittable and comfortable when wearing on.

CYCLOID CHAIN

TAG-BCD12-125



- M** Dyneema
D Length – 125 cm, Width – 12 mm
W 106 g
St End to end – 22 kN / Individual loop – 22 kN

It is personal secure chain for securing by connecting to seat belt.

NYLON DAISY CHAIN

TAG-BCN15-105



- M** Nylon 66
D Length – 105 cm, Width – 15 mm
W 94 g
St End to end – 22 kN / Individual loop – 2 kN

Light, strong and easy to carry with high strength nylon webbing.

DYNEEMA LOOP SLING 30/60/90/120

TAG-10D-30~120



- M** Dyneema
D Length – 30 / 60 / 90 / 120 cm, Width – 12 mm
W 14 g / 22 g / 34 g / 43 g
St 22 kN

Help more smooth rope flow connecting to belay anchor and easy to make equalizing two belay point.

DYNEEMA DAISY CHAIN 85/105

TAG-14D-2 / TAG-14D-1



- M** Dyneema
D Length – 85 cm / 105 cm, Width – 12 mm
W 42 g / 53 g
St End to end – 22 kN / Individual loop – 2 kN

Self-secure chain connecting to climbing harness.

15"/30" ALPINE EQUALIZER

TAG-27D-01 / TAG-27D-02

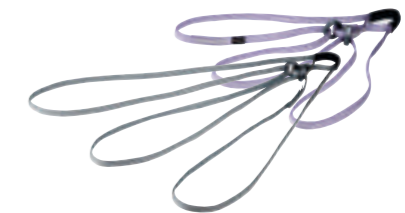

- M** Dyneema
D Length – 15" / 30", Width – 12 mm
W 62 g / 97 g
St End to end – 22 kN

Outstanding shock absorption also can make safe belay by equally dispersing strength on belay point.

NYLON LOOP SLING 30/60/90/120

TAG-SLN15-30~120



- M** Nylon 66
D Length – 30 / 60 / 90 / 120 cm, Width – 15 mm
W 28 g / 44 g / 69 g / 91 g
St 22 kN

Help more smooth rope flow connecting to belay anchor and easy to make equalizing two belay point.

MOUNTAIN WALL

TH-0901



- M** AL7075 + Nylon + Cordura
- S** S-M (23"~30"), L-XL (31"~38")
- W** 522 g (S size standard)

For more safer and comfort, wide padded waist and leg belts are connected with double belay loop.

VINCENT 2

TH-N01-2



- M** AL7075 + Nylon+ Cordura
- S** OSFA (24"~36")
- W** 460 g

OSFA(One Size Fits All) harness designed for middle level climbers.

VERTICAL

TH-01



- M** AL7075 + Nylon + Cordura
- S** OSFA (24"~36")
- W** 424 g

Most popular OSFA(One Size Fits All) light weight harness for all body type.

LIBERTY

TH-08



- M** AL7075 + Nylon + Cordura
- S** S-M (23"~30"), L-XL (31"~38")
- W** 402 g (S size standard)

Designed for best performance against variable climbing action, absorption/dispersion of falling shock.

GRAVITY

TH-N02



- M** AL7075 + Nylon + Cordura
- S** S (23"~26"), M (27"~30"), L (31"~34"), XL (35"~38")
- W** 350 g (S size standard)

Segmented sizes from S to XL for any user and reduced the belt weight.

JOYCL

THJ-02



- M** AL7075 + Nylon
- S** S (22"~27"), M (25"~30")
- W** 210 g (S size standard)

Designed to fit for kids and children's sports climbing and comfy even for long hours thanks to ergonomic design.

**JUNIOR**

TH-05



- M** AL7075 + Nylon + Cordura
- S** OSFA (18"~23")
- W** 394 g

Designed for 6~10 years old children.
(Max 40 kg)

**FULL BODY**

TH-04



- M** AL7075 + Nylon + Cordura
- S** OSFA (24"~36")
- W** 767 g

Best for rock climbing beginner, rescue, industrial & safety works.

**SAFE-RACK**

THZ-119



- M** AL7075 + Nylon + Cordura
- S** S-M (23"~30"), L-XL (31"~38")
- W** 1,261 g (S size standard)

Full body type harness designed for user's safety while various outdoor activities or industrial works by applying 4 loops and 2 belay loops.

**SAFE-ZIP**

THZ-219



- M** AL7075 + Nylon + Cordura
- S** S (18"~26"), M (27"~35"), L (36"~44")
- W** 1,051 g (S size standard)

Full body type harness designed for user's safety while various outdoor activities or industrial works by applying 1 loop and 2 belay loops.

**HOLLIS**

THS-01



- M** AL7075 + AL6066 + Nylon + Cordura + Polyester
- S** OSFA (26"~38")
- W** 2,149 g

Multi-purposed full body harness by separating upper body part to lower body part, which approved according to the European standards EN358, EN361, EN813.

**HALF**

TH-06

- M** AL7075 + Nylon + Cordura
- S** OSFA (24"~36")
- W** 252 g

Able to use as emergency belt in danger zone while ridge climbing.

**CHEST**

TH-07



- M** AL7075 + Nylon
- S** OSFA (31"~45")
- W** 260 g

Prevent hanging upside down while ridge or rock climbing, etc.

**SALVO**

THS-21



- M** AL7075 + Nylon
- S** OSFA (28"~42")
- W** 565 g

Approved by EN 358 waist belt that is used to secure your position in the work area.

01



NEW DOUBLE GEAR RACK
TAG-23



M Tarpaulin + Nylon
S Free
W 442 g

Designed for expert's gear rack which can reduce device's weight efficiently.

02



X-GEAR RACK
TAG-04



M Nylon
S Free
W 127 g

Can carry on both sides of shoulder with one strap and also prevent gear rack's leaning.

03



01 SQUARE DOUBLE LADDER 4+5
TAG-10-45

M AL7075 + Nylon
D 4+5 step / 140 cm
W 464 g
St 300 kg

04



02 DOUBLE LADDER 4+5
TAG-07-45

M Nylon
D 4+5 Step / 148 cm
W 456 g
St 300 kg

05



03 LADDER 5 STEP
TAG-07-05

M Nylon
D 5 Step / 148 cm
W 262 g
St 300 kg

06



04 LADDER 4 STEP
TAG-07-04

M Nylon
D 4 Step / 121 cm
W 225 g
St 300 kg

07



FIFI HOOK
TAG-1007



M AL7075 + Nylon
D 18 cm
W 23 g
St 4 kN

08



05 ALPINE LADDER 3 STEP
TAG-07D-03

M Dyneema + Nylon
D 3 Step / 126 cm
W 78 g
St 800 kg

06 ASCENDER STEP
TAG-1003

M AL7075 + Polyester
Rg min 25 cm ~ max 105 cm
W 134 g
St 300 kg

07 DOUBLE QUICK SECURE CHAIN
TSC-02

M AL7075 + Polyester
Rg min 25 cm ~ max 120 cm
W 216 g
St 300 kg

08 QUICK SECURE CHAIN
TSC-01

M AL7075 + Polyester
Rg min 25 cm ~ max 120 cm
W 110 g
St 300 kg

SALINON

TBP-CL-3501



M Nylon + Polyester
S 35+5 L
W 1,318 g
Cr Olive, Orange

Salinon is perfect 35L backpack for trekking and climbing.

PATRON

TBP-CL-4501



M Nylon + Polyester
S 45+5 L
W 1,610 g
Cr Burgundy, Blue

Patron is perfect 45L backpack for trekking and climbing.

CITY 35 / ROCK 45 / TREK 65 / EXTREME 85 / EXPEDITION 105

TCBT-01~05

M Polyester 1800D + Nylon
S 35+4 L / 45+5 L / 65+5 L / 85+7 L / 105+7 L
W 1,480 g / 1,600 g / 1,830 g / 2,000 g / 2,200 g

It is made in range of 35L, 45L, 65L, 85L, 105L capacity, which is suitable for carrying rope, equipment and other items from Gym to natural rocks and overseas expeditions.



CHALK BAG

TAG-19 / TAG-CB-01 / TAG-CB-02



M Polyester 600D / Nylon 210D / Nylon 210D
W 88 g / 42 g / 51 g

CHALK POT

TAG-CP-01



M Polyester 600D
D 25 × 20 × 22 mm
W 186 g
Cr Wine, Dark Green



MEGAN ICE GLOVES

TAG-IG-01

M Goatskin
S S, M, L, XL
W 132 g (S size standard)
Cr Black-White

BUCK / BILLY / AID BELAY GLOVES

TBG-1001 / TAG-BG-02 / TAG-BG-01

M Deerskin / Goatskin / Goatskin
S S, M, L, XL
W 96 g / 94 g / 92 g (S size standard)
Cr Brown / Tan / Black



RAPPEL RING 28

RAPPEL RING 39

TRR-28 / TRR-39
M AL6061
D Ø12 (inner dia 28 mm / 39 mm)
W 38 g / 48 g
St 30 kN



CHAIN ANCHOR

TAG-AR-01

M Stainless Steel
W 470 g
St 26 kN



CLIMBING TAPE

TAG-CT-01

M Cotton 100%
D 10 m × 3,8 cm



LIQUID CHALK 100 / 250

TAG-LC-02 / TAG-LC-01

M MgCO₃, Rosin, Alcohol
V 100 ml / 250 ml



BOLT HANGER

ANCHOR BOLT

TAG-12-1 / TAG-13-2
M STS304 / STS316
D t 4,0 / Ø10 × 60 mm
W 66 g / 43 g
St 25 kN



NUT KEY

TAG-08

M SCM435
D t 2,5
W 52 g



CRUSH CHALK

TAG-CP-250

M MgCO₃
W 250 g



SQUEEZE CHALK BALL

CHALK

TAG-CKR-01 / TAG-21-2
M MgCO₃
W 60 g / 200 g



ROPE PROTECTOR

TAG-RP-01

M Tarpaulin
D 10 × 60 cm
W 126 g



VOLTA CHAIR

TA-CL-01

M Fabric – Polyester 100%, Frame – Duralumin
D 54×60×104 cm (fold-out) / 11×11×38 cm (fold-in)
W 1,497 g (except pouch bag)
Cc 130 kg (suggested) / 160 kg (max)

NEW



MULTI NECK WARMER

TA-NW-01

M Polyester + Polyurethane
S Free



AL/PL/TL WAIST BELT

TA-06-1 / TA-06-2 / TA-06-3

M AL6061+PP / Acetal+PP / AL6061+PP
D Length-120 cm / Width-30 mm
W 50 g / 52 g / 52 g



WOOLLY

TA-S0-01

M Wool + Other
S S (23~25 cm), M (25~27 cm), L (27~29 cm)
Cr Green / Gray / Blue



COMPY

TA-SM-01 / TA-SW-01

M Cotton + Polyester + Polyurethane
S Free
Cr Blue / Pink